

Vikan

# Transport Catalogue





Where some say  
"your work",  
we say  
"your purpose".

## A different set of eyes

When Vikan visits a food processing plant, we see it through a different set of eyes. Where some see equipment and raw materials, we see risks and opportunities. Where some see brushes, brooms and mops, we see solutions to hygiene challenges. Where some say "your work," we say "your purpose." Because people who clean these facilities or otherwise work with hygiene are on the front line of keeping our food a delight to serve and safe to eat.

At Vikan we've been looking at food and beverage plants and other hygiene-sensitive environments in this way since 1898. Through integrity, diligence, ingenuity and drive, we've amassed the industry's biggest bank of hygiene and regulatory insight.

Based on this insight, we've developed the world's most effective professional range of cleaning tools and advisory services. All to make sure that you can deliver each and every product you manufacture with pride and confidence.

# Table of contents

---

Wall brackets	5
Brushes and brooms	8
Buckets	15
Squeegees	17
Handles	20
Shovels, fork & rake	28
Dustpan sets & dusters	30
Mops & cloths	32
Couplings	34
Waterguns & hoses	36
Kits	38
Advanced Cleaning Tools for the Transport Industry	40
The History of Vikan	41
Vissing Foundation	42
Contact page	43

# Product data icons

---



Couplings Size, "



Product Height, mm



Material



Max. cleaning temperature (Dishwasher), °C



Max usage temperature (food contact), °C



Recommended sterilisation temperature (Autoclave), °C



Shovel Blade Size L x W x H, mm



Content, Litre(s)



Box Quantity, Pcs.



Length/Depth, mm



Max. bars pressure, Bar



Max. Length, mm



Min. Bars pressure, Bar



Product Diameter, mm



Visible bristle length, mm



Product Width, mm



## Wall brackets

Keep your cleaning tools organised, increase their durability and service life, and minimise the risk of audit non-compliance with our comprehensive range of stainless steel and plastic wall brackets (with hooks and clips), and bucket brackets.

- Stainless steel wall brackets are strong and durable and hold between 1 - 6 cleaning tools.
- Plastic wall brackets are available in 9 different colours and hold between 1 - 6 cleaning tools.
- The high strength hooks of the plastic wall bracket can hold up to 10 kg.
- Stainless steel bucket brackets enable our buckets to be stored hygienically upside down.

6 Spare part pins for 1011x & 1013x

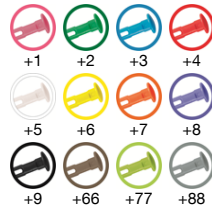
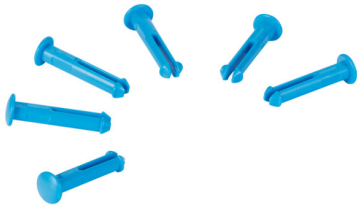

FDA   
Item no.: 1001

67 mm

121 °C

25 Pcs.

Material: Polypropylene

3 Spare part rubber bands for 1011x & 1013x

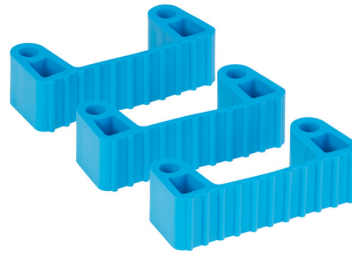

FDA   
Item no.: 1002

120 mm

121 °C

20 Pcs.

Material: TPE Rubber

Spare part Grip Band Module for 1011x, 1013x & HyGo, 5700x



FDA   
Item no.: 1003

80 mm

121 °C

15 Pcs.

Material: Polypropylene; TPE Rubber

Spare part hook for 1011x, 1012x & 1014x



FDA   
Item no.: 1004

76 mm

50 Pcs.

Material: Polyamide

Hygienic Hi-Flex Wall Bracket System, 420 mm



FDA   
Item no.: 1011

420 mm

121 °C

5 Pcs.

Material: Polypropylene; TPE Rubber; Polyamide

Hygienic Wall Bracket, Single Hook Module, 41 mm



FDA   
Item no.: 1012

41 mm

121 °C

5 Pcs.

Material: Polypropylene; Polyamide

Hygienic Wall Bracket, Grip Band Module, 82 mm



FDA   
Item no.: 1013

82 mm

121 °C

5 Pcs.

Material: Polypropylene; TPE Rubber; Polyamide

Hygienic Wall Bracket, Double Hook Module, 82 mm



FDA   
Item no.: 1014

82 mm

121 °C

10 Pcs.

Material: Polypropylene; Polyamide

Bracket for bucket, 5686x, 5688x, 5692x and 5694x, 370 mm



Item no.: 16200

370 mm

1 Pcs.

Material: Stainless Steel (AISI 304)

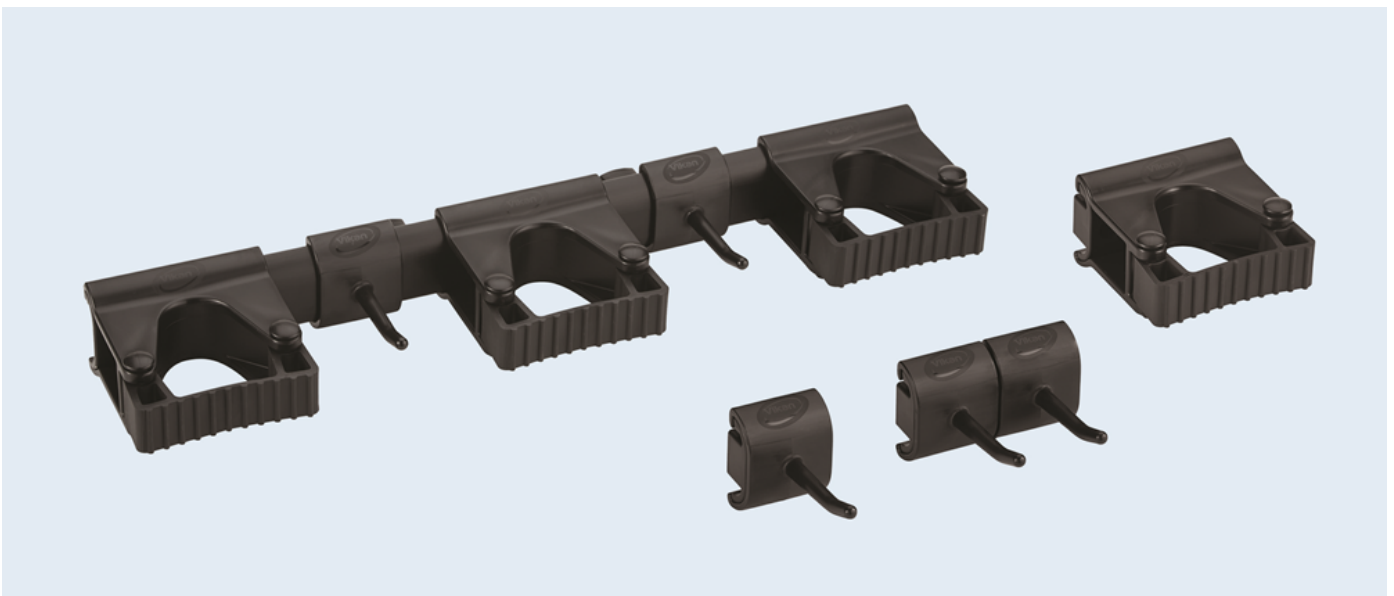



# Brushes

Vikan offers a very wide range of highly effective, durable brushes and brooms in various shapes and sizes for use in a multitude of applications in every industry setting. There are brushes for food and beverage applications, general cleaning, and vehicle cleaning, in a range of highly specialised designs.

Our brush and broom range includes several Ultra Safe Technology (UST) products, which feature hygienic design making them suitable for use in high-risk environments.

- All brushes and brooms are designed with ergonomics in mind from the dimensions of their handle to the angle of their bristles.
- A wide range of bristle options are available including short, long, split, soft, medium, hard, mixed, heat resistant, and angle cut making it possible to find a brush or broom that meets your needs.
- Scrubbing brushes and brooms are ideal for wet or dry cleaning of stubborn dirt
- Soft brooms are ideal for sweeping powders and other loose dry material.
- Some brushes and brooms are also available as water-fed options.
- Easy-to-clean UST brushes reduce the risk of contaminant build-up on the cleaning tools themselves.

Garage Broom, FSC™ 100%  
PBN-COC-059222, 440 mm, Hard, Black



Item no.: 311552



58 mm



1 Pcs.

Material: Wood; PVC; Polyamide (regenerated material); Copper-plated steel

Garage Broom, FSC™ 100%  
PBN-COC-059222, 665 mm, Hard, Black



Item no.: 311752



58 mm



1 Pcs.

Material: Wood; PVC; Polyamide (regenerated material); Copper-plated steel

Interior Brush, 330 mm, Hard, Black



Item no.: 450052



330 mm



5 Pcs.

Material: Polyester (PBT); Polypropylene (regenerated material); Copper-plated steel

Hand Brush w/Short Handle, 330 mm, Soft, Black



Item no.: 450252



330 mm



5 Pcs.

Material: Polyester (PBT); Polypropylene (regenerated material); Copper-plated steel

Vehicle Brush, waterfed, 270 mm, Soft/split, Black



Item no.: 475552



52 mm



1 Pcs.

Material: Polypropylene (regenerated material); TPE Rubber; Polyester (PBT); Copper-plated steel

Vehicle Brush, waterfed, 370 mm, Soft/split, Black



Item no.: 475752



52 mm



1 Pcs.

Material: Polypropylene (regenerated material); TPE Rubber; Polyester (PBT); Copper-plated steel

Snow Brush with Ice Scraper, 490 mm, Hard, Black



Item no.: 520052



490 mm



10 Pcs.

Material: PVC; Polypropylene (regenerated material); Copper-plated steel

Snow Brush, 335 mm, Hard, Black



Item no.: 521552



335 mm



10 Pcs.

Material: Polypropylene (regenerated material); TPE Rubber; Polyester (PET); Horse tail hair; Polypropylene; Copper-plated steel

Vehicle Brush w/Long Handle, 420 mm, Soft/split, Black



Item no.: 522252



420 mm



5 Pcs.

Material: Polyester (PBT); Copper-plated steel; Polypropylene (regenerated material)

Vehicle Brush w/Short Handle, 275 mm, Soft/split, Black



Item no.: 522752



275 mm



5 Pcs.

Material: Polyester (PBT); Polypropylene (regenerated material); Copper-plated steel

Hand Brush, 320 mm, Soft/split, Black



Item no.: 524652



320 mm



5 Pcs.

Material: Polypropylene (regenerated material); Polyester (PBT); Copper-plated steel; TPE Rubber

Washing Brush, waterfed, 275 mm, Soft/split, Black



Item no.: 524752



275 mm



1 Pcs.

Material: Polypropylene (regenerated material); TPE Rubber; Polyester (PBT); Copper-plated steel

Multi-Purpose Hand Brush, Large, 345 mm, Soft, Black



Item no.: 524952

345 mm

7 Pcs.

Material: Polypropylene; Polyester (PBT); TPE Rubber

Rim Brush, 325 mm, Soft, Black



Item no.: 525052

325 mm

65 mm

12 Pcs.

Material: Polypropylene; Horse tail hair; Polyester (PET); Zinc

Multi Brush/Rim Cleaner, 310 mm, Soft/split, Black



Item no.: 525252

310 mm

9 Pcs.

Material: Polypropylene (regenerated material); TPE Rubber; Polyester (PBT); Copper-plated steel

Rim Cleaner, 325 mm, Hard, Black



Item no.: 525352

325 mm

65 mm

12 Pcs.

Material: Polypropylene; Polyester (PBT); Polyester (PET); Zinc

Vehicle Brush, waterfed (C), 360 mm, Soft/split, Black



Item no.: 525452

360 mm

5 Pcs.

Material: Polyester (PBT); Polypropylene (regenerated material); Copper-plated steel

Alloy Wheel Brush, Large, Ø105 mm, 425 mm, Soft, Black



Item no.: 525652

425 mm

105 mm

1 Pcs.

Material: Polypropylene; Polyester (PBT)

Vehicle Brush, waterfed, 250 mm, Soft/split, Black



Item no.: 526852

250 mm

1 Pcs.

Material: Polypropylene; Polyester (PBT)

Vehicle Brush, waterfed, 225 mm, Soft/split, Black



Item no.: 526952

225 mm

1 Pcs.

Material: Polypropylene (regenerated material); TPE Rubber; Polyester (PBT); Copper-plated steel

Tube Brush f/flexible handle 53515 or 53525, Ø12 mm, 200 mm, Medium



FDA  
Item no.: 5354

200 mm

12 mm

121 °C

10 Pcs.

Material: Polyester (PBT); Stainless Steel (AISI 303Cu); Stainless Steel (AISI 304Cu)

Tube Brush f/flexible handle 53515 or 53525, Ø60 mm, 200 mm, Medium

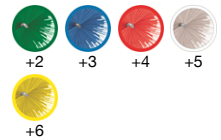
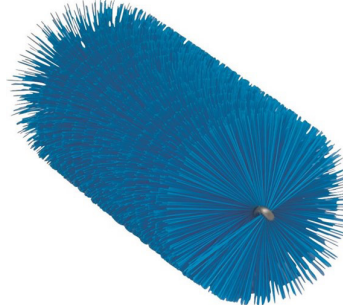

FDA  
Item no.: 5356

200 mm

60 mm

121 °C

12 Pcs.

Material: Polyester (PBT); Stainless Steel (AISI 303Cu); Stainless Steel (AISI 304Cu)

Tube Brush f/flexible handle 53515 or 53525, Ø20 mm, 200 mm, Medium



FDA  
Item no.: 5365

200 mm

20 mm

121 °C

10 Pcs.

Material: Polyester (PBT); Stainless Steel (AISI 303Cu); Stainless Steel (AISI 304Cu)

Tube Brush f/flexible handle 53515 or 53525, Ø40 mm, 200 mm, Medium



FDA  
Item no.: 5368

200 mm

40 mm

121 °C

10 Pcs.

Material: Polyester (PBT); Stainless Steel (AISI 303Cu); Stainless Steel (AISI 304Cu)

Tube Brush f/flexible handle 53515 or 53525, Ø90 mm, 200 mm, Medium

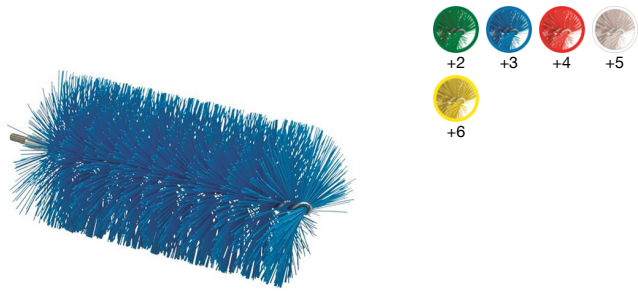

Item no.: 5391	200 mm	90 mm	121 °C	10 Pcs.

Material: Polyester (PBT); Stainless Steel (AISI 303Cu); Stainless Steel (AISI 304Cu)

Tube Brush f/flexible handle 53515 or 53525, Ø120 mm, 210 mm, Medium

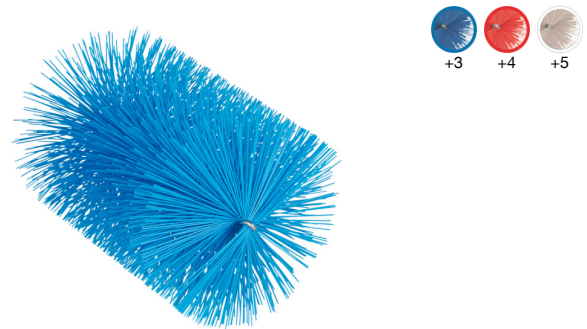

Item no.: 5394	210 mm	120 mm	121 °C	10 Pcs.

Material: Polyester (PBT); Stainless Steel (AISI 303Cu); Stainless Steel (AISI 304Cu)

Tube Brush f/flexible handle 53515 or 53525, Ø140 mm, 210 mm, Medium

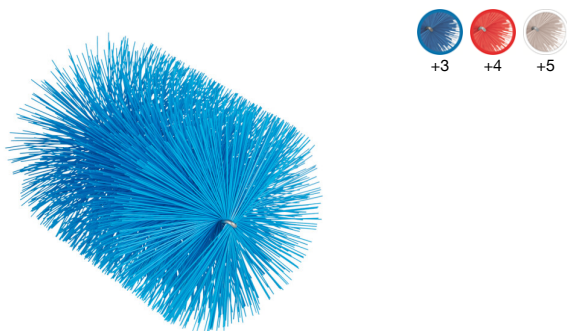

Item no.: 5396	210 mm	140 mm	121 °C	10 Pcs.

Material: Polyester (PBT); Stainless Steel (AISI 303Cu); Stainless Steel (AISI 304Cu)

Rim Cleaner, waterfed, 228 mm, Soft/split, Black



Item no.: 545252	228 mm	2 Pcs.

Material: Polyester (PBT); Copper-plated steel; Polypropylene (regenerated material)

Set of Detail Brushes, 7 pcs., 140 mm, Soft,



Item no.: 556052	140 mm 10 Pcs.

Material: Polypropylene; Polyethylene (HDPE)

Set of Detail Brushes, 30 + 50 mm, 390 mm, Soft,



Item no.: 556452	390 mm 10 Pcs.

Material: Polypropylene; Polyethylene (HDPE)

Interior Brush, 155 mm, Medium, Black



Item no.: 631559



155 mm



36 Pcs.

Material: Polypropylene; Horse tail hair; Stainless Steel (AISI 304)

Nail Brush, 120 mm, Hard, Black



Item no.: 644052



120 mm



15 Pcs.

Material: Polyester (PBT); Stainless Steel (AISI 304); Polypropylene (regenerated material)





## Buckets

Store, transport, mix and clean products of any type with award-winning Vikan buckets and lids. Hygienic, ergonomically designed and stackable, these bucket systems are remarkably versatile and easy to work with.

- Hygienically designed buckets hold 6, 12 or 20 L.
- Strong and durable with stainless-steel handles.
- Temperature and chemical resistant.
- Available in a range of food contact compliant colours.
- Ergonomically designed.
- Feature easy-to-read measures.

Bucket, 12 Litre



FDA   
 Item no.: 5686

320 mm

12 Litre(s)

121 °C

6 Pcs.

Material: Polypropylene; Stainless Steel (AISI 304)

Lid f/Bucket 5686x, 12 Litre



FDA   
 Item no.: 5687

12 Litre(s)

6 Pcs.

Material: Polypropylene

Bucket, 6 Litre



FDA   
 Item no.: 5688

260 mm

6 Litre(s)

121 °C

5 Pcs.

Material: Polypropylene; Stainless Steel (AISI 304)

Lid f/Bucket 5688, 6 Litre



FDA   
 Item no.: 5689

6 Litre(s)

5 Pcs.

Material: Polypropylene





# Squeegees

Effectively remove both liquids and debris with Vikan's pioneering range of squeegees. Choose from,

- Floor and hand squeegees – featuring high density foam blades and easy to replace blade cassettes. Highly efficient at removing liquids from surfaces, and cost effective. Available in fixed and swivel necked, hand held and floor cleaning options and with easy to remove cassettes.
- Hygienic squeegees – featuring twin rubber blades in an easy to remove cassette for hygienic cleaning and maintenance. These squeegees are heat and chemical resistant and highly efficient at removing liquids and semi solids from surfaces. Available in fixed and swivel necked, hand held and floor cleaning options.
- Ultra-Hygienic squeegees – featuring a fully moulded, hygienically designed single flexible blade. Designed for use in areas where hygiene is critical but effective at removing liquids, semi-solids and loose dry material from any surface, anywhere. Floor and hand-held versions are available in up to 9 different colours.
- Condensation squeegee - specifically designed to remove condensation from ceilings and overhead pipework. Condensate can be drained safely to the floor drain, via the hollow handle and a hose, or collected in a bottle that fits easily and securely on to the waterfed handle.
- Vikan also has a comprehensive range of squeegees designed specifically for vehicle cleaning.

Windscreen Scraper w/Sponge, 545 mm, Black



Item no.: 473752

545 mm

12 Pcs.

Material: Polypropylene; Synthetic rubber

Head f/Windscreen Scraper 473752 & 473952, 200 mm, Black



Item no.: 473852

200 mm

24 Pcs.

Material: Polypropylene; Synthetic rubber

Windscreen Scraper w/Sponge & Telescopic Handle, 710 mm, Black



Item no.: 473952

710 mm

12 Pcs.

Material: Anodised Aluminium; Polyamide

Wipe-N-Shine, 250 mm, Black



Item no.: 707752

250 mm

6 Pcs.

Material: SEBS; POM (regenerated material)

Wipe-N-Shine, 350 mm, Black



Item no.: 707852

350 mm

6 Pcs.

Material: SEBS; POM (regenerated material)

Wipe-N-Shine, 450 mm, Black



Item no.: 707952

450 mm

5 Pcs.

Material: SEBS; POM (regenerated material)

Floor Squeegee, 400 mm, Black



Item no.: 708849



400 mm



12 Pcs.

Material: Polypropylene; Cellular rubber (oil resistant)

Floor Squeegee, 600 mm, Black



Item no.: 708869



600 mm



12 Pcs.

Material: Polypropylene; Cellular rubber (oil resistant)









## Handles

Every head needs a handle and at Vikan our range of handles is nearly as comprehensive as the heads they are designed to fit on to. Whether you need a plastic, stainless steel, aluminium or wooden handle, or one that's hygienically designed, short, long, telescopic, water-fed, or colour-coded, we are sure to have one that suits your needs.

- Ultra Hygienic handles, primarily designed for use with the Colour-coded product range, are available in a range of colours, and lengths, are fully moulded and easy to clean. The Ultra Hygienic handles compliment the UST broom range and Ultra Hygiene squeegees perfectly.
- The Ultra Hygienic Mini handles are ideal for use with any hand held Vikan product.
- The lightweight, ergonomically designed aluminium handles minimise the risk of occupational injury and the water-fed versions feature quick-release hose connections and insulated sleeves for a comfortable grip. Suitable for use with our Colour-coded, Microfibre and Transport product ranges.
- The ridged stainless steel handles are strong, durable, chemical resistant and suitable for use with our Colour-coded products.
- The flexible stainless-steel and nylon handles mounted on our twisted wire brush heads facilitate cleaning of curved pipework.
- Telescopic handles enable cleaning at height of remote surfaces more easily and effectively.
- Vikan's top adjustable handle, featuring a button on the handle head that allows quick and easy adjustment of the handle length, is uniquely designed for use with our Microfibre product range.
- Our traditional high quality wooden handle range are exclusively designed for use with our Classic range of products.





Wooden Handle, FSC® Mix Credit  
 PBN-COC-059222, Ø25mm, 1560 mm, Black



 Item no.: 292515552	Material: Wood; Polypropylene (regenerated material)	 25 mm	 1560 mm	 10 Pcs.
--	---	---	--	--





Aluminium Handle, Ø31 mm, 1505 mm, Black



 Item no.: 293752	Material: Anodised Aluminium; Polypropylene (regenerated material)	 31 mm	 1505 mm	 10 Pcs.
---	---	---	--	--

Aluminium Telescopic Handle w/Hose Nozzle,  
 waterfed, 1080 - 1600 mm, Ø32 mm, Black



Item no.: 297152	Material: Anodised Aluminium; Polypropylene; Chromium-plated brass	 32 mm	 1080 mm	 5 Pcs.	 6 Bar
---------------------	---	--	--	---	--

Aluminium Telescopic Handle, waterfed, w/Click Coupling (C), 1060 - 1600 mm, Ø32 mm, Black



Item no.:	Material:				
297152C	Anodised Aluminium; Polypropylene; Chromium-plated brass	32 mm	1060 mm	5 Pcs.	6 Bar

Aluminium Telescopic Handle, waterfed w/Q coupling, 1060 mm, Black



Item no.:	Material:				
297152Q	Anodised Aluminium; Polypropylene; Chromium-plated brass	32 mm	1060 mm	5 Pcs.	6 Bar





Aluminium Telescopic Handle w/Hose Nozzle, waterfed, 1600 - 2780 mm, Ø32 mm, Black



Item no.:	Material:				
297352	Anodised Aluminium; Polypropylene; Chromium-plated brass	32 mm	1600 mm	5 Pcs.	6 Bar





Aluminium Telescopic waterfed Handle w/Click Coupling (C), 1600 - 2780 mm, Ø32 mm, Black



Item no.:	Material:				
297352C	Anodised Aluminium; Polypropylene; Chromium-plated brass	32 mm	1600 mm	5 Pcs.	6 Bar





Aluminium Telescopic Handle waterfed, w/Q Coupling (Q), 1600 - 2780 mm, Ø32 mm, Black



Item no.:	Material:				
297352Q	Anodised Aluminium; Polypropylene; Chromium-plated brass	32 mm	1600 mm	5 Pcs.	6 Bar



Aluminium Telescopic waterfed Handle with on/off Click Coupling (C), 1060 - 1600 mm, Ø32 mm, Black



Item no.:	Material:				
297452C	Anodised Aluminium; Polypropylene; Chromium-plated brass	32 mm	1060 mm	5 Pcs.	6 Bar





Aluminium Telescopic Handle, 1575 mm, Black



Item no.:	Material:			
297552	Anodised Aluminium; Polypropylene	32 mm	1575 mm	5 Pcs.





Aluminum Handle w/Hose Nozzle, waterfed, Ø31 mm, 1560 mm, Black



Item no.:	Material:				
299152	Anodised Aluminium; Polypropylene; Chromium-plated brass	31 mm	1560 mm	10 Pcs.	6 Bar

Aluminum Handle w/Quick Coupling, waterfed (Q), Ø31 mm, 1540 mm, Black



Item no.:	Material:				
299152Q	Anodised Aluminium; Polypropylene; Chromium-plated brass	31 mm	1540 mm	10 Pcs.	6 Bar

Aluminum Handle w/Hose Nozzle, waterfed,  
 Ø31 mm, 1025 mm, Black



Item no.:	Material:				
299252	Anodised Aluminium; Polypropylene; Chromium-plated brass	31 mm	1025 mm	10 Pcs.	6 Bar

Aluminum Handle, waterfed, Q-Coupling (Q),  
 Ø31 mm, 1010 mm, Black



Item no.:	Material:				
299252Q	Anodised Aluminium; Polypropylene	31 mm	1010 mm	10 Pcs.	6 Bar

Aluminum Handle, waterfed, Q-Coupling and  
 on/off Water Switch (Q), Ø31 mm, 1575 mm,  
 Black



Item no.:	Material:				
299552Q	Anodised Aluminium; Polypropylene; Chromium-plated brass	31 mm	1575 mm	10 Pcs.	6 Bar

Aluminum Handle w/Hose Nozzle, waterfed,  
 Ø31 mm, 1935 mm, Black



Item no.:	Material:				
299752	Anodised Aluminium; Polypropylene; Chromium-plated brass	31 mm	1935 mm	10 Pcs.	6 Bar

Aluminum Handle, waterfed, Q-Coupling (Q),  
 Ø31 mm, 1920 mm, Black



Item no.:	Material:				
299752Q	Anodised Aluminium; Polypropylene; Chromium-plated brass	31 mm	1920 mm	10 Pcs.	6 Bar

Angle Thread, 140 mm, Black



Item no.: 29989	140 mm	10 Pcs.
Material: Polyamide; Stainless Steel (AISI 304)		

Flexible extension handle f/53515, Ø5 mm, 812 mm



FDA  
Item no.: 5346

Material:  
Stainless Steel (AISI 303); Stainless Steel (AISI 304Cu); Stainless Steel (AISI 303Cu)

5 mm

812 mm

121 °C

10 Pcs.

Flexible Handle, stainless steel, Ø5 mm, 755 mm, White



FDA  
Item no.: 53515

Material:  
Stainless Steel (AISI 304); Polypropylene; Stainless Steel (AISI 303Cu)

5 mm

755 mm

121 °C

10 Pcs.





## Shovels, forks and rakes

Ergonomically designed Vikan shovels, forks and rakes come in various sizes and shapes for almost any application – including food handling.

The shovels can be used for moving large amounts of ingredients waste or even snow.

- Lightweight, durable and ergonomically designed.
- Some shovels feature holes for rapid liquid drainage.
- The shovel is available in a metal-detectable version.
- Hygienic fork available for emptying fresh produce from large containers during harvest.

Shovel, 271 mm, Black



Item no.: 561552



951 mm



340 x 270 x 75 mm



1 Pcs.

Material: Polypropylene; Anodised Aluminium

Hand shovel, 275 mm, Green



Item no.: 5673



550 mm



121 °C



327 x 271 x 50 mm



12 Pcs.

Material: Polypropylene





## Dustpan set & dusters

Collect debris of any kind and dust from floors and work surfaces using Vikan's range of dustpans, dustpan sets and dusters.

- Colour-coded, food-contact-compliant dustpans with fully aligned edge make sure all dust and debris are collected.
- Long-handled dustpans eliminate the need to bend over or kneel.
- Dusters available with telescopic handles.
- Wool and microfibre dusters available.
- Colour coded Closable Dustpan Set complete with angle cut bristle broom, for ergonomic, all-in-one sweeping.

Duster w/Telescopic Handle, 1070 - 1730 mm, Ø190 mm, Soft/split, Grey



Item no.: 454518

1070 mm

190 mm

12 Pcs.

Material: Polypropylene; Polyethylene (HDPE); Steel

Detachable head to 454518, Ø190 mm, Soft/split, Grey



Item no.: 454618

190 mm

12 Pcs.

Material: Polyethylene (HDPE); Polypropylene

Dustpan, metal, 245 mm, Black



Item no.: 558552

245 mm

10 Pcs.

Material: Galvanized Metal

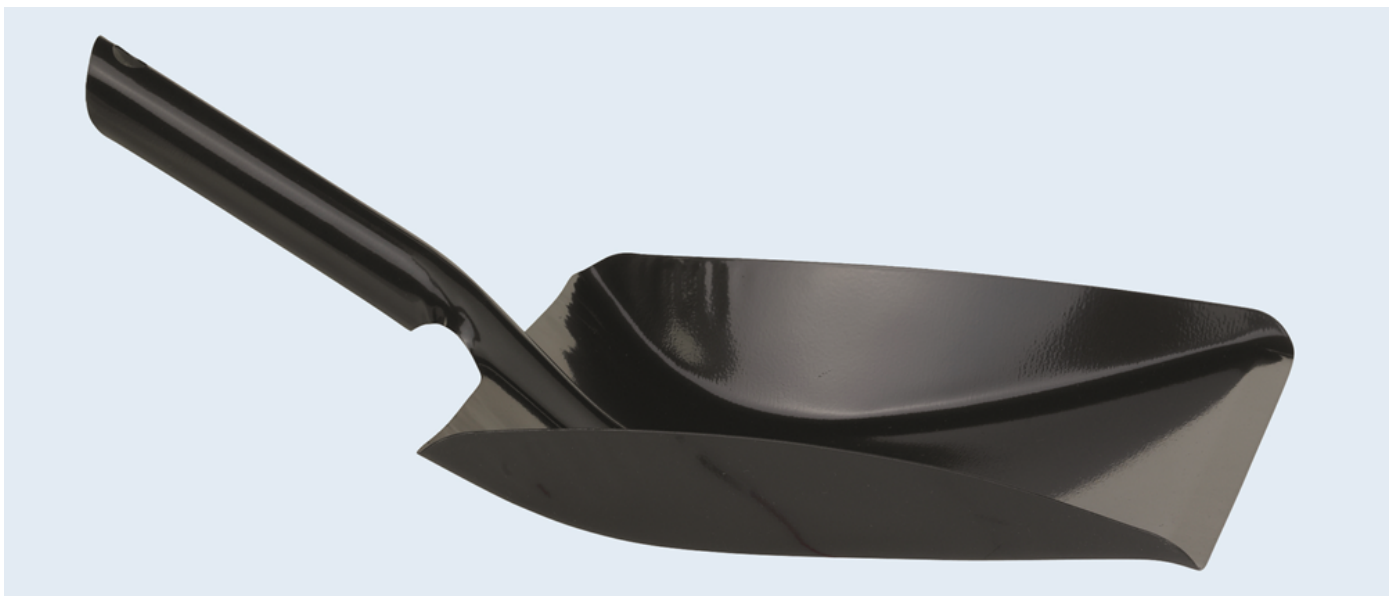



## Transport Microfiber

The products are made from premium microfiber, a material trusted by car care professionals. Its ultra-fine fibres gently lift and trap dirt, dust, and water without scratching or leaving streaks. Microfiber holds several times its own weight in liquid, making washing and drying faster, safer, and more effective than with traditional materials.

- The complete microfiber range for a safe, scratch-free shine.
- Achieve a flawless finish every time with our new microfiber range.
- Safe, effective, and built for car enthusiasts who want the best.

Microfibre Washing Pad, Double sided, 20 x 25 cm, 200 mm x 250 mm

NEW



Item no.: 552052

50 Pcs.

Material: 80% Polyester, 20% Polyamide (90% Microfibre)

Microfibre Washing Glove, Double sided, 300 mm x 230 mm

NEW



Item no.: 691252

50 Pcs.

Material: 80% Polyester, 20% Polyamide (90% Microfibre)

Microfibre Drying Cloth, 400 mm x 400 mm

NEW



Item no.: 692052

400 mm

2 Pcs.

Material: 70% Polyester, 30% Polyamide (90% Microfibre)





# Couplings

Vikan offers high-quality couplings that make attaching and changing hoses and sprayers quick and easy.

- Couplings come in ½" and ¾" sizes.
- Quick Fit couplings are designed to make changing spraying equipment more easy and efficient.
- Quick fit couplings are designed to make it easier to mount hoses on water taps, handles and foaming equipment.

Hose Nozzle, 1/2" & 3/4"



Item no.: 0708



10 Pcs.



25 Bar

Material: Chromium-plated brass; Synthetic rubber

Quick Fit Hose Coupling with 1/2" thread for 9324x, 3/4"(Q)



Item no.: 0715



10 Pcs.



25 Bar

Material: Chromium-plated brass; Synthetic rubber

Adapter Quick Coupling (Q) to Gardena/Hozelock Nozzle, 1/2" (C)



Item no.: 88070752



10 Pcs.



25 Bar

Material: Chromium-plated brass; Synthetic rubber

Nozzle with 1/2" Thread for Gardena/Hozelock hose coupling, 1/2" (C)



Item no.: 88070952



10 Pcs.



25 Bar

Material: Chromium-plated brass; Synthetic rubber

Hose Coupling 1/2" for 3/4" Hose (Q)



Item no.: 88071352



10 Pcs.



25 Bar

Material: Chromium-plated brass; Galvanized steel (DIN 1.09035); Synthetic rubber



## Water guns & hoses

We offer water guns and hoses for use in a variety of industries and applications. Versatile and effective, our water guns are used to clean everything from food service areas to changing rooms at sports facilities and even swimming pools. Our hoses are designed for use with hot or cold water, and come in ½" couplings and various lengths.

- Gun sprayers feature functional design with continually variable water pressure.
- Water guns available with angled jets to hit hard-to-reach places.
- Cold water hoses can be used with water up to 40 degrees Celsius.
- Hot water hoses are designed for use with water up to 70 degrees Celsius.

Heavy Duty Water Gun

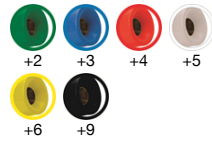

Item no.: 9324



1 Pcs.



24 Bar

Material: Brass; EPDM rubber; Stainless Steel (AISI 304)

Cold water hose, 1/2" (Q), 10000 mm, Transparent



Item no.: 93315



1/2 "



1 Pcs.



12 Bar

Material: PVC; Chromium-plated brass; Polyester (PBT)

Cold water hose, 1/2" (Q), 15000 mm, Transparent



Item no.: 93325



1/2 "



1 Pcs.



12 Bar

Material: PVC; Chromium-plated brass; Polyester (PBT)





## Kits

Vikan offers a range of different cleaning kits for specific applications. The EasyShine Kit can be used for cleaning windows, mirrors, white boards, ceramic tiles, stainless steel and other high-gloss surfaces. Our Easy Hi Dust Microfibre Kit cleans up to 3-metres high with static electricity and a flexible head. The Campaign Set and the Transport set feature vehicle brushes with water-fed, telescopic aluminium handles.

- All you or your customers need in one convenient kit.
- A great way to get started with Vikan products.

Campaign Set, 3 Brushes, 340 mm, , Black



Item no.: 521052

340 mm

6 Pcs.

Material: See materials on the individual products in the kit

Transport campaign Kit, 2 brushes & 1 250 mm Wipe-N-Shine, 340 mm, , Black



Item no.: 521152

340 mm

6 Pcs.

Material: See materials on the individual products in the kit

Campaign Set, 526852 + 297152C, 1065 mm, , Black



Item no.: 521452

1065 mm

1 Pcs.

Material: See materials on the individual products in the kit

Vikan Transport System Starter Pack with On/Off, 1065 mm, , Black, Black



Item no.: 521652

1065 mm

1 Pcs.

Material: See materials on the individual products in the kit

Transport System Starter Pack, 1325 mm, ,



Item no.: 990052

1325 mm

1 Pcs.

Material: See materials on the individual products in the kit

Transport System Starter Pack with On/Off (C)



Item no.: 990054

1325 mm

1 Pcs.

Material: See materials on the individual products in the kit

# Advanced cleaning tools for the transport industry



At Vikan, we design cleaning products with you in mind. That's why we partner with transport industry professionals to develop and refine the Transport range. Input from you has led to innovations such as rubber edges to prevent paint scratches, and telescopic handles that ensure longer reach so it's easier to clean large vehicles.

The Vikan Transport range features more than 70 professional cleaning tools designed to help you clean the interior and exterior of any type of vehicle effectively and efficiently.



# Vikan's History



## Since 1898

When Vikan was founded in the nineteenth-century Danish countryside, our company was part of a close-knit rural community. We developed our products not to “meet industry needs”, but to help people we knew personally – people we talked to about their cleaning challenges and aspirations.

“I decided I needed to visit the dairies to learn what they were using brushes for. I did this and observed their work carefully... I then experimented to come up with brush types I thought the dairy workers would appreciate ... I even sent samples for the dairies to try out.”

— A.P. Pedersen, Vikan founder\*

“This guiding principle still forms our starting point today. We get to know our customers, we work hard to understand their needs, and we innovate tools that are genuinely useful, even involving our customers in the development process.”

— Carsten Bo Pedersen, Vikan CEO



VISSING FONDEN

# Vissing Foundation

## Owned by the Vissing Foundation

Vikan is ninety percent owned by the Vissing Foundation, a charity established in 1979 by former Vikan owner Mogens Vissing and his wife Jenny.

The Vissing Foundation funds important research in cancer and diabetes treatment, with an emphasis on devices, diagnostic methods, treatment approaches, data analysis and other areas that directly affect patient health and wellbeing. The foundation's work is a source of pride for all of us in the Vikan family.



# Get in touch

Your local Vikan Distributor is ready and very well equipped to meet your every need for Vikan products, services, and up-to-date expert knowledge and advice.

Vikan Distributors maintain an exceptionally close relationship with Vikan. They take part in regular training initiatives, and they are happy to offer guidance on what products to use, how to use them effectively, and how to keep auditors and other authorities not just satisfied, but impressed with, your operation.

No matter where in the world you do business, you'll find a Vikan Distributor nearby.



## Contact Us

**Vikan international**

Islands Brygge 39, 2. sal  
DK-2300 København  
Denmark

Tel.: +45 96 14 26 10

[export@vikan.com](mailto:export@vikan.com)

