

Vikan

Hygiene Catalogue





Where some say
"your work",
we say
"your purpose".

A different set of eyes

When Vikan visits a food processing plant, we see it through a different set of eyes. Where some see equipment and raw materials, we see risks and opportunities. Where some see brushes, brooms and mops, we see solutions to hygiene challenges. Where some say "your work," we say "your purpose." Because people who clean these facilities or otherwise work with hygiene are on the front line of keeping our food a delight to serve and safe to eat.

At Vikan we've been looking at food and beverage plants and other hygiene-sensitive environments in this way since 1898. Through integrity, diligence, ingenuity and drive, we've amassed the industry's biggest bank of hygiene and regulatory insight.

Based on this insight, we've developed the world's most effective professional range of cleaning tools and advisory services. All to make sure that you can deliver each and every product you manufacture with pride and confidence.

Table of contents

Wall brackets	5
Brushes and brooms	9
Buckets	26
Squeegees	29
Scrapers	36
Handles	41
Scoops	50
Shovels, fork & rake	53
Mixers	57
Scouring pads and holders	60
Dustpan sets & dusters	62
Cleaning trolleys	64
Foaming equipment	66
Couplings	70
Waterguns & hoses	73
Accessories	76
Vissing Foundation	78
Contact page	79

Product data icons



Couplings Size, "



Product Height, mm



Material



Max. cleaning temperature (Dishwasher), °C



Max usage temperature (food contact), °C



Recommended sterilisation temperature (Autoclave), °C



Shovel Blade Size L x W x H, mm



Content, Litre(s)



Box Quantity, Pcs.



Length/Depth, mm



Max. bars pressure, Bar



Max. Length, mm



Min. Bars pressure, Bar



Product Diameter, mm



Visible bristle length, mm



Product Width, mm



Wall brackets

Keep your cleaning tools organised, increase their durability and service life, and minimise the risk of audit non-compliance with our comprehensive range of stainless steel and plastic wall brackets and bucket brackets.

- Stainless steel wall brackets are strong and durable and hold between 1 - 6 cleaning tools.
- Plastic wall brackets are available in 12 different colours and hold between 1 - 5 cleaning tools.
- Stainless steel bucket brackets enable our buckets to be stored hygienically upside down.

Wall Bracket, 240 mm

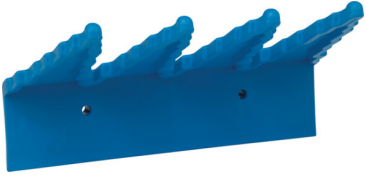
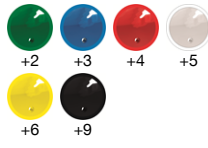
Item no.: 0615	240 mm	100 °C	1 Pcs.
----------------	--------	--------	--------

Material: Polypropylene; TPE Rubber

Wall Bracket for 1 product, 48 mm



Item no.: 0616	48 mm	121 °C	1 Pcs.
----------------	-------	--------	--------

Material: Stainless Steel (AISI 304)

Wall Bracket for 4 Products, 305 mm



Item no.: 0617	305 mm	121 °C	1 Pcs.
----------------	--------	--------	--------

Material: Stainless Steel (AISI 304)

Wall Bracket for 6 Products, 460 mm



Item no.: 0618	460 mm	121 °C	1 Pcs.
----------------	--------	--------	--------

Material: Stainless Steel (AISI 304)

6 Spare part pins for 1011x & 1013x

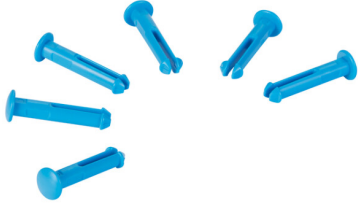
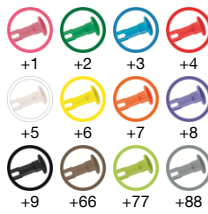
Item no.: 1001	67 mm	121 °C	25 Pcs.
----------------	-------	--------	---------

Material: Polypropylene

3 Spare part rubber bands for 1011x & 1013x

Item no.: 1002	120 mm	121 °C	20 Pcs.
----------------	--------	--------	---------

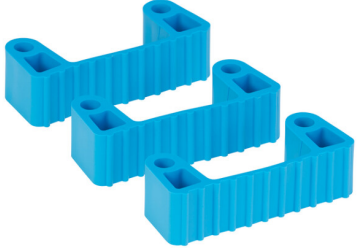
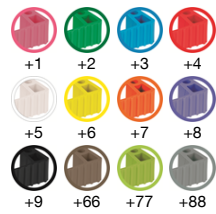
Material: TPE Rubber

Spare part Grip Band Module for 1011x, 1013x & HyGo, 5700x



FDA
 Item no.: 1003

80 mm

121 °C

15 Pcs.

Material: Polypropylene; TPE Rubber

Spare part hook for 1011x, 1012x & 1014x



FDA
 Item no.: 1004

76 mm

50 Pcs.

Material: Polyamide

Hygienic Hi-Flex Wall Bracket System, 420 mm



FDA
 Item no.: 1011

420 mm

121 °C

5 Pcs.

Material: Polypropylene; TPE Rubber; Polyamide

Hygienic Wall Bracket, Single Hook Module, 41 mm



FDA
 Item no.: 1012

41 mm

121 °C

5 Pcs.

Material: Polypropylene; Polyamide

Hygienic Wall Bracket, Grip Band Module, 82 mm



FDA
 Item no.: 1013

82 mm

121 °C

5 Pcs.

Material: Polypropylene; TPE Rubber; Polyamide

Hygienic Wall Bracket, Double Hook Module, 82 mm



FDA
 Item no.: 1014

82 mm

121 °C

10 Pcs.

Material: Polypropylene; Polyamide

Bracket for bucket, 5686x, 5688x, 5692x
and 5694x, 370 mm



Item no.: 16200

370 mm

1 Pcs.

Material: Stainless Steel (AISI 304)

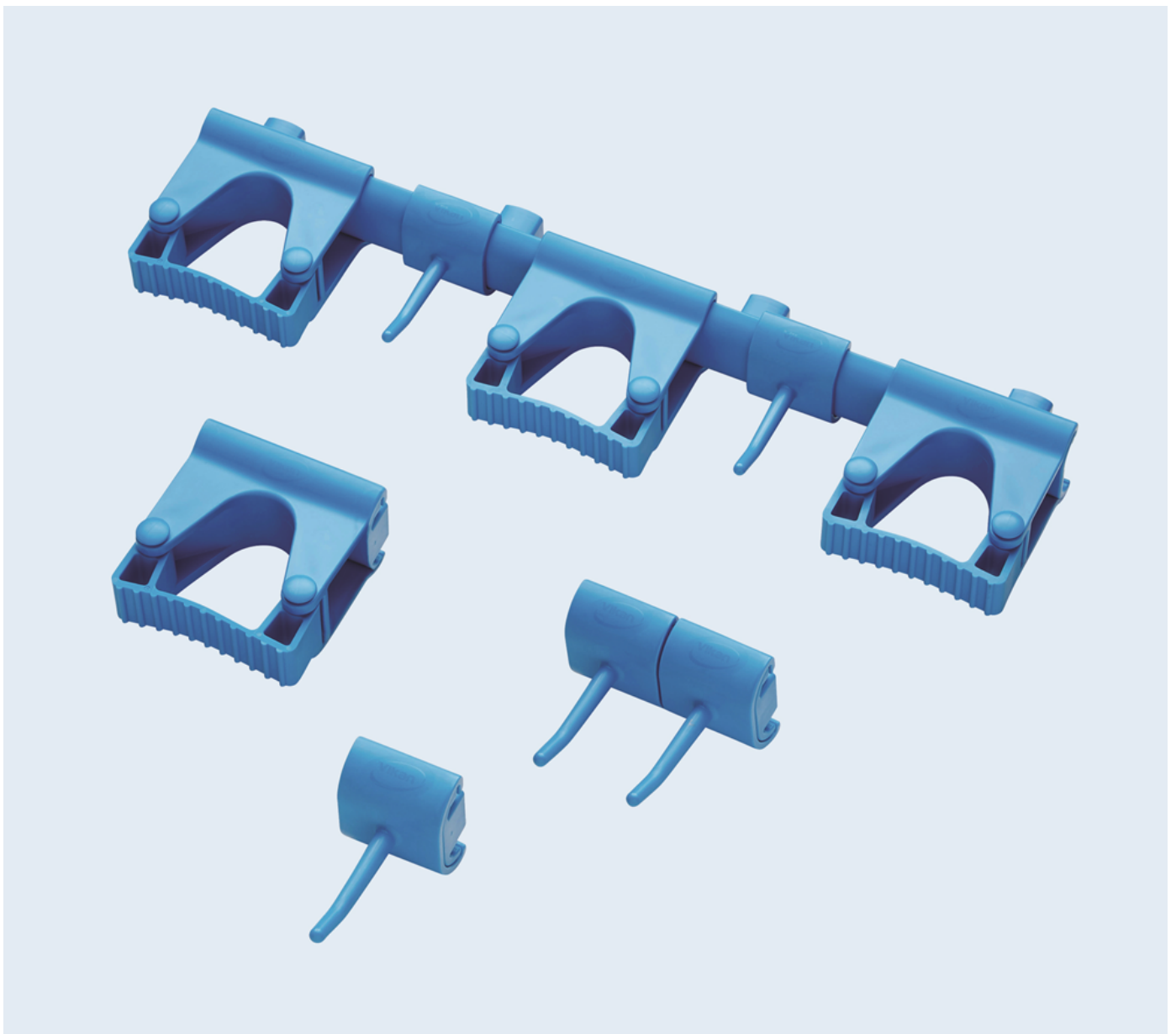



Brushes

Vikan offers a very wide range of highly effective, durable brushes and brooms in various shapes and sizes for use in a multitude of applications in every industry setting. There are brushes for food and beverage applications, general cleaning, and vehicle cleaning, in a range of highly specialised designs.

Our brush and broom range includes several Ultra Safe Technology (UST) products, which feature hygienic design making them suitable for use in high-risk environments.

- All brushes and brooms are designed with ergonomics in mind from the dimensions of their handle to the angle of their bristles.
- A wide range of bristle options are available including short, long, split, soft, medium, hard, mixed, heat resistant, and angle cut making it possible to find a brush or broom that meets your needs.
- Scrubbing brushes and brooms are ideal for wet or dry cleaning of stubborn dirt
- Soft brooms are ideal for sweeping powders and other loose dry material.
- Some brushes and brooms are also available as water-fed options.
- Easy-to-clean UST brushes reduce the risk of contaminant build-up on the cleaning tools themselves.

Broom, Angle Cut, 290 mm, Very hard

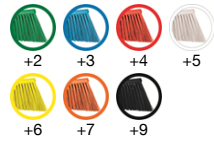

Item no.: 2914



170 mm



121 °C



10 Pcs.

Material: Polypropylene; Stainless Steel (AISI 304); Polyester (PET)

Broom, 330 mm, Very hard



Item no.: 2915



105 mm



121 °C



8 Pcs.

Material: Polypropylene; Stainless Steel (AISI 304); Polyester (PET)

Broom, 530 mm, Very hard



Item no.: 2920



105 mm



121 °C



4 Pcs.

Material: Polypropylene; Stainless Steel (AISI 304); Polyester (PET)

Toaster Brush, 2 pcs., 395 mm, Medium, Red



Item no.: 30024



46 mm



121 °C



25 Pcs.

Material: Polypropylene; Polyphenylene Sulfide (PPS); Stainless Steel (AISI 304)

Utility Brush, 260 mm, Medium



Item no.: 3088



22 mm



121 °C



20 Pcs.

Material: Polyester (PBT); Polypropylene; Stainless Steel (AISI 304)

Dustpan Broom with Angled Thread, 250 mm, Medium

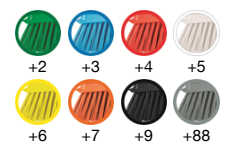

Item no.: 3103



250 mm



121 °C



10 Pcs.

Material: Polypropylene; Polyester (PBT); Stainless Steel (AISI 304)

Lobby Broom, 260 mm, Soft/hard

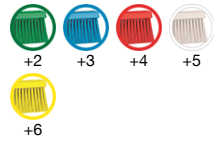

FDA
Item no.: 3104

75 mm

121 °C

10 Pcs.

Material: Polypropylene; Polyester (PBT); Stainless Steel (AISI 304L)

Broom w/ Straight Neck, 310 mm, Medium

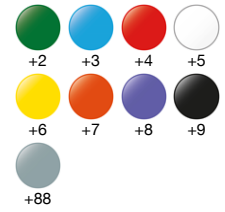

FDA
Item no.: 3166

78 mm

121 °C

15 Pcs.

Material: Polypropylene; Polyester (PBT); Stainless Steel (AISI 304L)

UST Broom, 400 mm, Soft



FDA
Item no.: 3171

54 mm

10 Pcs.

Material: Polyester (PBT); Glass reinforced; Polypropylene

UST Broom, 400 mm, Medium



FDA
Item no.: 3173

54 mm

10 Pcs.

Material: Polyester (PBT); Glass reinforced; Polypropylene

Broom, 410 mm, Soft/hard

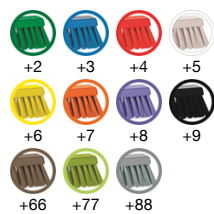

FDA
Item no.: 3174

60 mm

121 °C

10 Pcs.

Material: Polypropylene; Polyester (PBT); Stainless Steel (AISI 304L)

Broom, 410 mm, Soft/split



FDA
Item no.: 3178

60 mm

85 °C

10 Pcs.

Material: Polypropylene; Stainless Steel (AISI 304)

Broom, 410 mm, Soft



FDA
Item no.: 3179

56 mm

121 °C

10 Pcs.

Material: Polypropylene; Polyester (PBT); Stainless Steel (AISI 304L)

Broom, 610 mm, Soft/hard

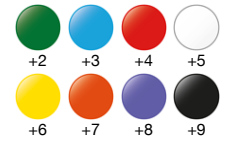

FDA
Item no.: 3194

60 mm

121 °C

10 Pcs.

Material: Polypropylene; Polyester (PBT); Stainless Steel (AISI 304L)

Broom, 610 mm, Soft



FDA
Item no.: 3199

56 mm

121 °C

10 Pcs.

Material: Polypropylene; Polyester (PBT); Stainless Steel (AISI 304L)

Hand Brush M, 165 mm, Medium



FDA
Item no.: 3587

20 mm

121 °C

20 Pcs.

Material: Polypropylene; Polyester (PBT); Stainless Steel (AISI 304L)

Round Hand Scrub, 110 mm, Hard

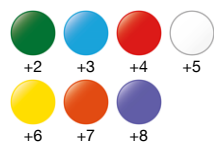

FDA
Item no.: 3885

44 mm

121 °C

15 Pcs.

Material: Polypropylene; Polyester (PBT); Stainless Steel (AISI 304L)

Hand Brush L, 200 mm, Hard



FDA
Item no.: 3890

36 mm

121 °C

15 Pcs.

Material: Polypropylene; Polyester (PBT); Stainless Steel (AISI 304L)

UST Hand Brush, 176 mm, Hard



FDA
 Item no.: 3891

176 mm

121 °C

10 Pcs.

Material: Polypropylene; Polyester (PBT)

XL Hand Brush, 230 mm, Very hard



FDA
 Item no.: 3894

230 mm

121 °C

10 Pcs.

Material: Polypropylene; Polyester (PBT); Stainless Steel (AISI 304)

Detail Brush with Scraping Edge, 150 mm, Hard

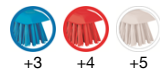

FDA
 Item no.: 3951

150 mm

121 °C

10 Pcs.

Material: Polypropylene; Polyester (PBT)

UST Hand Brush w/short handle, 260 mm, Hard



FDA
 Item no.: 4179

37 mm

10 Pcs.

Material: Polyester (PBT); Glass reinforced; Polypropylene

Glazing Brush w/long Handle, 415 mm, Soft, Blue



FDA
 Item no.: 41813

60 mm

121 °C

10 Pcs.

Material: Polypropylene; Polyester (PBT); Stainless Steel (AISI 304)

Narrow Cleaning Brush with Long Handle, 420 mm, Hard



FDA
 Item no.: 4185

420 mm

10 Pcs.

Washing Brush w/long handle, 415 mm, Hard

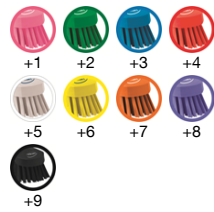

FDA
Item no.: 4186

36 mm

121 °C

10 Pcs.

Material: Polypropylene; Polyester (PBT); Stainless Steel (AISI 304L)

Washing Brush w/short Handle, 270 mm, Hard

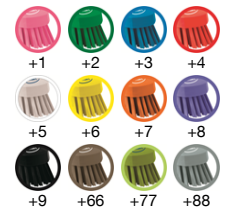

FDA
Item no.: 4192

36 mm

121 °C

10 Pcs.

Material: Polypropylene; Polyester (PBT); Stainless Steel (AISI 304L)

Washing Brush w/short Handle, 270 mm, Soft/split



FDA
Item no.: 4194

40 mm

10 Pcs.

Material: Polypropylene; Stainless Steel (AISI 304); Polyester (PBT)

Narrow Hand Brush w/Short Handle, 300 mm, Very hard

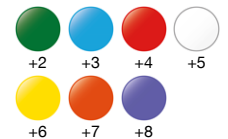

FDA
Item no.: 4195

33 mm

121 °C

10 Pcs.

Material: Polypropylene; Polyester (PBT); Stainless Steel (AISI 304L)

UST Hand Brush w/long Handle, 395 mm, Hard



FDA
Item no.: 4196

37 mm

10 Pcs.

Material: Polyester (PBT); Glass reinforced; Polypropylene

Ultra-Slim Cleaning Brush with Long Handle, 600 mm, Medium

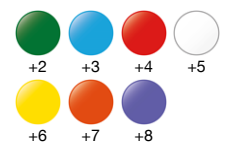

FDA
Item no.: 4197

40 mm

121 °C

10 Pcs.

Material: Polyester (PBT); Stainless Steel (AISI 304)

Washing Brush with short handle, 270 mm, Soft



FDA
Item no.: 4198

270 mm

121 °C

10 Pcs.

Material: Polypropylene; Polyester (PBT); Stainless Steel (AISI 304)

Dish Brush w/Scraping Edge, 280 mm, Medium



FDA
Item no.: 4237

23 mm

121 °C

20 Pcs.

Material: Polypropylene; Polyester (PBT); Stainless Steel (AISI 304L)

Dish Brush, 290 mm, Medium



FDA
Item no.: 4287

24 mm

121 °C

20 Pcs.

Material: Polypropylene; Polyester (PBT); Stainless Steel (AISI 304L)

Brush w/Heat Resistant Filaments, 290 mm, Hard, White



FDA
Item no.: 42885

22 mm

175 °C

10 Pcs.

Material: Polypropylene; Polyphenylene Sulfide (PPS); Stainless Steel (AISI 304L)

Detail Brush, 205 mm, Very hard



FDA
Item no.: 4401

15 mm

121 °C

10 Pcs.

Material: Polypropylene; Polyester (PBT); Stainless Steel (AISI 304L)

Detail Brush with heat resistant filaments, 205 mm, Very hard, Blue



FDA
Item no.: 44023

205 mm

175 °C

10 Pcs.

Material: Polypropylene; Polyphenylene Sulfide (PPS); Stainless Steel (AISI 304)

UST Bench Brush, 330 mm, Soft



FDA
Item no.: 4581

57 mm

10 Pcs.

Material: Polyester (PBT); Glass reinforced; Polypropylene

Powder Brush, 300 mm, Soft



FDA
Item no.: 4582

40 mm

121 °C

10 Pcs.

Material: Polypropylene; Polyester (PBT); Stainless Steel (AISI 304L)

UST Bench Brush, 330 mm, Medium



FDA
Item no.: 4585

57 mm

10 Pcs.

Material: Polyester (PBT); Glass reinforced; Polypropylene

Hand Brush, 330 mm, Soft

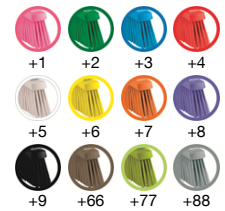

FDA
Item no.: 4587

52 mm

121 °C

15 Pcs.

Material: Polypropylene; Polyester (PBT); Stainless Steel (AISI 304L)

Hand Brush, 330 mm, Medium

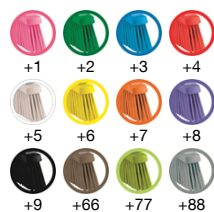

FDA
Item no.: 4589

50 mm

121 °C

15 Pcs.

Material: Polypropylene; Polyester (PBT); Stainless Steel (AISI 304L)

Scrubbing Brush - heat resistant filaments, 150 mm, Very hard, White



FDA
Item no.: 47535

20 mm

180 °C

5 Pcs.

Material: Polypropylene; Polyphenylene Sulfide (PPS); Stainless Steel (AISI 304L)

Toilet Brush w/Holder & Wall Bracket, 720 mm, Medium, White



Item no.: 50515	720 mm	100 °C	10 Pcs.
-----------------	--------	--------	---------

Material: Polyester (PBT); Galvanized steel (S235); Polypropylene (regenerated material); Polypropylene

Tube Brush f/flexible handle 53515 or 53525, Ø12 mm, 200 mm, Medium



Item no.: 5354	200 mm	12 mm	121 °C	10 Pcs.
----------------	--------	-------	--------	---------

Material: Polyester (PBT); Stainless Steel (AISI 303Cu); Stainless Steel (AISI 304Cu)

Tube Brush f/flexible handle 53515 or 53525, Ø60 mm, 200 mm, Medium

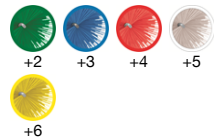
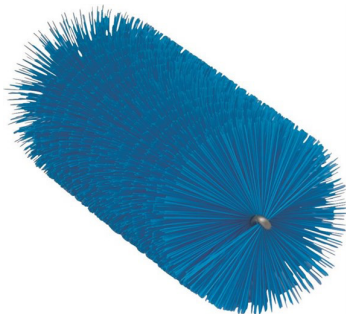

Item no.: 5356	200 mm	60 mm	121 °C	12 Pcs.
----------------	--------	-------	--------	---------

Material: Polyester (PBT); Stainless Steel (AISI 303Cu); Stainless Steel (AISI 304Cu)

Brush Kit f/Softice Machines, White



Item no.: 53575	490 mm	5 Pcs.
-----------------	--------	--------

Material: Polyester (PBT); Polypropylene; Stainless Steel (AISI 304L); Stainless Steel (AISI 304Cu)

Brush Kit f/Softice Machines, Red



Item no.: 53584	500 mm	5 Pcs.
-----------------	--------	--------

Material: Polyester (PBT); Polypropylene; Stainless Steel (AISI 304L); Stainless Steel (AISI 304Cu)

Tube Brush, Ø15 mm, 310 mm, Hard



Item no.: 5360	310 mm	15 mm	121 °C	15 Pcs.
----------------	--------	-------	--------	---------

Material: Polypropylene; Polyester (PBT); Stainless Steel (AISI 304Cu)

Drain Cleaning Brush, 275 mm, Hard, Black



Item no.: 53619	275 mm	55 mm	121 °C	10 Pcs.
-----------------	--------	-------	--------	---------

Material: Polyamide; Polyester (PBT); Stainless Steel (AISI 304)

Cleaning set w/3 Brushes, Ø2, Ø6, Ø6 mm, 150 mm, Soft



+3	+4	+5
----	----	----

Item no.: 5362	150 mm	121 °C	10 Pcs.
----------------	--------	--------	---------

Material: Polyester (PBT); Stainless Steel (AISI 304)

Tube Brush, Ø9 mm, 370 mm, Medium



+2	+5
----	----

Item no.: 5363	370 mm	9 mm	121 °C	15 Pcs.
----------------	--------	------	--------	---------

Material: Polypropylene; Polyester (PBT); Stainless Steel (AISI 304Cu)

Tube Brush f/flexible handle 53515 or 53525, Ø20 mm, 200 mm, Medium

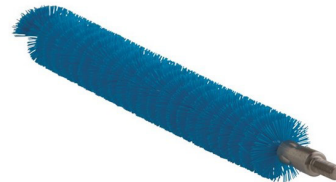

+2	+3	+4	+5
+6			

Item no.: 5365	200 mm	20 mm	121 °C	10 Pcs.
----------------	--------	-------	--------	---------

Material: Polyester (PBT); Stainless Steel (AISI 303Cu); Stainless Steel (AISI 304Cu)

Tube Brush f/flexible handle 53515 or 53525, Ø40 mm, 200 mm, Medium



+2	+3	+4	+5
+6			

Item no.: 5368	200 mm	40 mm	121 °C	10 Pcs.
----------------	--------	-------	--------	---------

Material: Polyester (PBT); Stainless Steel (AISI 303Cu); Stainless Steel (AISI 304Cu)

Tube Brush, Ø60 mm, 500 mm, Medium



+1	+2	+3	+4
+5	+6	+7	+8
+9			

Item no.: 5370	500 mm	60 mm	121 °C	15 Pcs.
----------------	--------	-------	--------	---------

Material: Polypropylene; Polyester (PBT); Stainless Steel (AISI 304Cu)

Pipe Exterior Brush, 530 mm, Soft, Blue



Item no.: 53713	530 mm	121 °C	5 Pcs.

Material: Polyamide; Polyester (PBT); Stainless Steel (AISI 304)

Pipe Exterior Brush, Ø55 mm, 360 mm, Medium

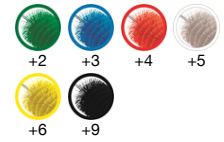

Item no.: 5372	360 mm	55 mm	121 °C	10 Pcs.

Material: Polyester (PBT); Stainless Steel (AISI 304); Polypropylene

Pipe Exterior Brush, 510 mm, Medium, Blue



Item no.: 53743	510 mm	121 °C	5 Pcs.

Material: Polyamide; Polyester (PBT); Stainless Steel (AISI 304)

Tube Brush, Ø10 mm, 500 mm, Hard

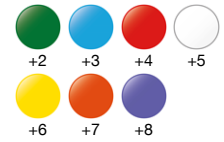

Item no.: 5375	500 mm	10 mm	121 °C	15 Pcs.

Material: Polypropylene; Polyester (PBT); Stainless Steel (AISI 304Cu)

Tube Brush, Ø20 mm, 500 mm, Medium



Item no.: 5376	500 mm	20 mm	121 °C	15 Pcs.

Material: Polypropylene; Polyester (PBT); Stainless Steel (AISI 304Cu)

Tube Brush, Ø40 mm, 500 mm, Hard

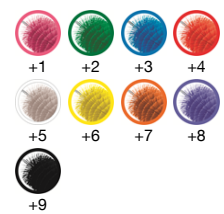

Item no.: 5378	500 mm	40 mm	121 °C	15 Pcs.

Material: Polypropylene; Polyester (PBT); Stainless Steel (AISI 304Cu)

Tube Brush, Ø50 mm, 500 mm, Medium

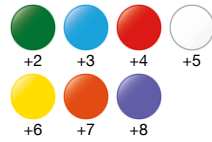

Item no.: 5379		500 mm	50 mm	121 °C	15 Pcs.

Material: Polypropylene; Polyester (PBT); Stainless Steel (AISI 304Cu)

Pipe Cleaning Brush f/handle, Ø103 mm, Medium

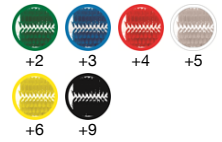

Item no.: 5380103		170 mm	103 mm	121 °C	10 Pcs.

Material: Polypropylene; Polyester (PBT); Stainless Steel (AISI 304L)

Pipe Cleaning Brush f/handle, Ø175 mm, Medium



Item no.: 5380175		160 mm	175 mm	121 °C	10 Pcs.

Material: Polypropylene; Polyester (PBT); Stainless Steel (AISI 304L)

Pipe Cleaning Brush f/handle, Ø50 mm, Hard

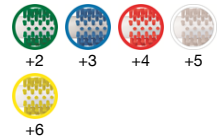
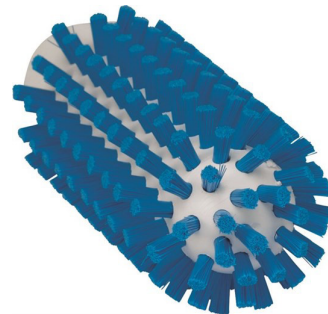

Item no.: 538050		140 mm	50 mm	121 °C	10 Pcs.

Material: Polypropylene; Polyester (PBT); Stainless Steel (AISI 304L)

Pipe Cleaning Brush f/handle, Ø63 mm, Hard

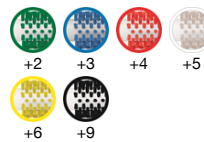

Item no.: 538063		145 mm	63 mm	121 °C	10 Pcs.

Material: Polypropylene; Polyester (PBT); Stainless Steel (AISI 304L)

Pipe Cleaning Brush f/handle, Ø77 mm, Medium

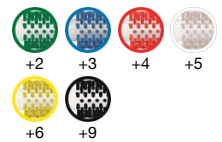

Item no.: 538077		155 mm	77 mm	121 °C	10 Pcs.

Material: Polypropylene; Polyester (PBT); Stainless Steel (AISI 304L)

Pipe Cleaning Brush f/handle, Ø90 mm, Medium

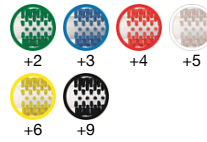

Item no.: 538090		160 mm	90 mm	121 °C	10 Pcs.

Material: Polypropylene; Polyester (PBT); Stainless Steel (AISI 304L)

Pipe Brush w/handle, one piece, 430 mm, Medium/hard

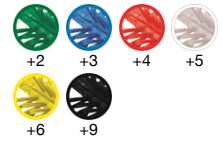

Item no.: 538190		430 mm	90 mm	121 °C	10 Pcs.

Material: Polypropylene; Polyester (PBT); Stainless Steel (AISI 304)

Tube Brush f/flexible handle 53515 or 53525, Ø90 mm, 200 mm, Medium

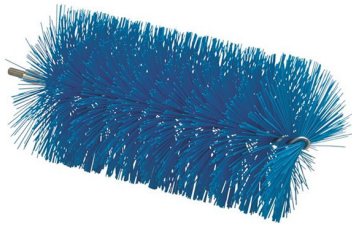

Item no.: 5391		200 mm	90 mm	121 °C	10 Pcs.

Material: Polyester (PBT); Stainless Steel (AISI 303Cu); Stainless Steel (AISI 304Cu)

Tube Brush f/flexible handle 53515 or 53525, Ø120 mm, 210 mm, Medium

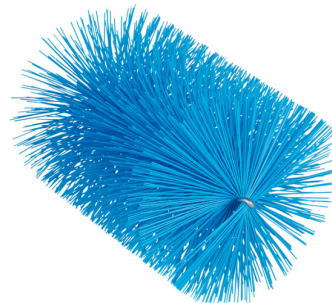

Item no.: 5394		210 mm	120 mm	121 °C	10 Pcs.

Material: Polyester (PBT); Stainless Steel (AISI 303Cu); Stainless Steel (AISI 304Cu)

Tube Brush f/flexible handle 53515 or 53525, Ø140 mm, 210 mm, Medium

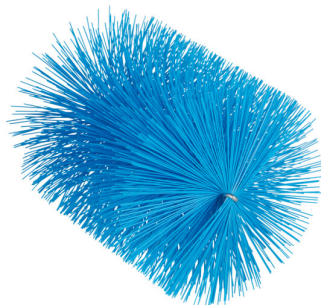

Item no.: 5396		210 mm	140 mm	121 °C	10 Pcs.

Material: Polyester (PBT); Stainless Steel (AISI 303Cu); Stainless Steel (AISI 304Cu)

UST Detail Brush, 30 mm, Soft



Item no.: 555130			205 mm	121 °C	10 Pcs.

Material: Polypropylene; Polyester (PBT)

Pastry Brush, 30 mm, Soft

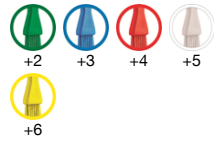

FDA
 Item no.: 555230

45 mm

121 °C

10 Pcs.

Material: Polypropylene; Polyester (PBT); Stainless Steel (AISI 304)

Pastry Brush, 50 mm, Soft



FDA
 Item no.: 555250

45 mm

121 °C

10 Pcs.

Material: Polypropylene; Polyester (PBT); Stainless Steel (AISI 304)

Pastry Brush, 70 mm, Soft



FDA
 Item no.: 555270

45 mm

121 °C

10 Pcs.

Material: Polypropylene; Polyester (PBT); Stainless Steel (AISI 304)

Hand Brush S / Nailbrush, 130 mm, Hard



FDA
 Item no.: 6440

17 mm

121 °C

25 Pcs.

Material: Polypropylene; Polyester (PBT); Stainless Steel (AISI 304L)

UST Tank Brush, 190 mm, Hard



FDA
 Item no.: 7030

190 mm

121 °C

5 Pcs.

Material: Polypropylene; Polyester (PBT)

Meat Mincer Brush, 130 mm, Medium

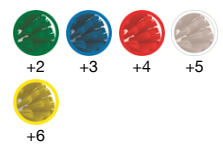

FDA
 Item no.: 7035

130 mm

135 mm

121 °C

8 Pcs.

Material: Polypropylene; Polyester (PBT); Stainless Steel (AISI 304L)

Tank Brush, 205 mm, Hard

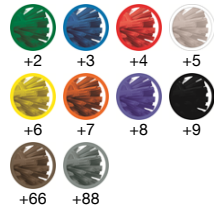

FDA
Item no.: 7037

40 mm

121 °C

10 Pcs.

Material: Polypropylene; Polyester (PBT); Stainless Steel (AISI 304L)

Tank Brush, 205 mm, Medium

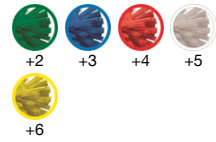

FDA
Item no.: 7039

40 mm

85 °C

10 Pcs.

Material: Polypropylene; Stainless Steel (AISI 304L)

Crevice Scrub, 225 mm, Very hard

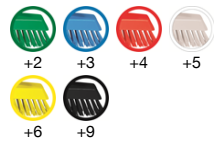

FDA
Item no.: 7040

225 mm

121 °C

10 Pcs.

Material: Polypropylene; Polyester (PBT); Stainless Steel (AISI 304)

Deck Scrub, waterfed, 270 mm, Very hard

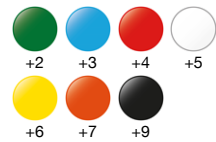

FDA
Item no.: 7041

24 mm

121 °C

10 Pcs.

Material: Polypropylene; Polyester (PBT); Stainless Steel (AISI 304L)

Compact Wall/Deck Scrub, 225 mm, Hard

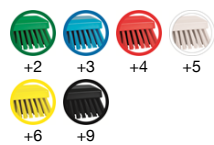

FDA
Item no.: 7042

42 mm

121 °C

10 Pcs.

Material: Polyester (PBT); Polypropylene; Stainless Steel (AISI 304)

Deck Scrub, waterfed, 270 mm, Medium



FDA
Item no.: 7043

32 mm

121 °C

10 Pcs.

Material: Polypropylene; Polyester (PBT); Stainless Steel (AISI 304L)

High-Low Brush, 265 mm, Medium

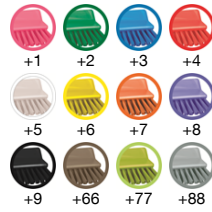

FDA
Item no.: 7047

45 mm

121 °C

10 Pcs.

Material: Polypropylene; Polyester (PBT); Stainless Steel (AISI 304L)

Hand Brush, waterfed, 330 mm, Hard



FDA
Item no.: 7057

330 mm

121 °C

10 Pcs.

Material: Polypropylene; Stainless Steel (AISI 304); Polyester (PBT)

Wall-/Floor Washing Brush, 305 mm, Hard



FDA
Item no.: 7060

44 mm

121 °C

16 Pcs.

Material: Polypropylene; Polyester (PBT); Stainless Steel (AISI 304L)

Wall-/Floor Washing Brush, 470 mm, Hard



FDA
Item no.: 7062

44 mm

121 °C

8 Pcs.

Material: Polypropylene; Polyester (PBT); Stainless Steel (AISI 304L)

UST Deck Scrub, 400 mm, Hard



FDA
Item no.: 7064

37 mm

10 Pcs.

Material: Polyester (PBT); Glass reinforced; Polypropylene

Washing Brush w/Angle adjustment, waterfed, 240 mm, Soft/split

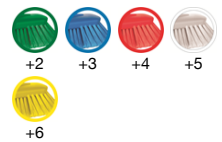

FDA
Item no.: 7067

44 mm

4 Pcs.

Material: Polypropylene; Stainless Steel (AISI 304); Polyester (PBT)

Broom, 300 mm, Medium



FDA 
Item no.: 7068

60 mm

121 °C

10 Pcs.

Material: Polypropylene; Polyester (PBT); Stainless Steel (AISI 304L)





Buckets

Store, transport, mix and clean products of any type with award-winning Vikan buckets and lids. Hygienic, ergonomically designed and stackable, these bucket systems are remarkably versatile and easy to work with.

- Hygienically designed buckets hold 6, 12 or 20 L.
- Strong and durable with stainless-steel handles.
- Temperature and chemical resistant.
- Available in a range of food contact compliant colours.
- Ergonomically designed.
- Feature easy-to-read measures.

Bucket, Metal Detectable, 12 Litre

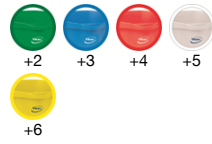

FDA Item no.: 5694

320 mm

121 °C

6 Pcs.

Material: Polypropylene; Metal & X-Ray detectable additive

Lid f/Bucket 5694; Metal Detectable, 12 Litre



FDA Item no.: 5695

365 mm

121 °C

6 Pcs.

Material: Polypropylene; Metal & X-Ray detectable additive





Squeegees

Effectively remove both liquids and debris with Vikan's pioneering range of squeegees. Choose from,

- Floor and hand squeegees – featuring high density foam blades and easy to replace blade cassettes. Highly efficient at removing liquids from surfaces, and cost effective. Available in fixed and swivel necked, hand held and floor cleaning options and with easy to remove cassettes.
- Hygienic squeegees – featuring twin rubber blades in an easy to remove cassette for hygienic cleaning and maintenance. These squeegees are heat and chemical resistant and highly efficient at removing liquids and semi solids from surfaces. Available in fixed and swivel necked, hand held and floor cleaning options.
- Ultra-Hygienic squeegees – featuring a fully moulded, hygienically designed single flexible blade. Designed for use in areas where hygiene is critical but effective at removing liquids, semi-solids and loose dry material from any surface, anywhere. Floor and hand-held versions are available in up to 12 different colours.
- Condensation squeegee - specifically designed to remove condensation from ceilings and overhead pipework. Condensate can be drained safely to the floor drain, via the hollow handle and a hose, or collected in a bottle that fits easily and securely on to the waterfed handle.
- Vikan also has a comprehensive range of squeegees designed specifically for vehicle cleaning.

Ultra Hygiene Table Squeegee w/Mini Handle, 245 mm



FDA
Item no.: 7125

245 mm

121 °C

20 Pcs.

Material: Polypropylene; TPE Rubber

Ultra Hygiene Squeegee, 400 mm



FDA
Item no.: 7140

400 mm

121 °C

15 Pcs.

Material: Polypropylene; TPE Rubber

Ultra Hygiene Squeegee, 500 mm

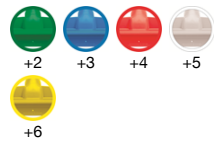

FDA
Item no.: 7150

500 mm

121 °C

15 Pcs.

Material: Polypropylene; TPE Rubber

Ultra Hygiene Squeegee, 600 mm



FDA
Item no.: 7160

600 mm

121 °C

15 Pcs.

Material: Polypropylene; TPE Rubber

Ultra Hygiene Squeegee, 700 mm

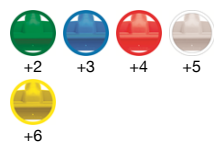

FDA
Item no.: 7170

700 mm

121 °C

15 Pcs.

Material: Polypropylene; TPE Rubber

Squeegee, Angle Adjustable for 5662x, 5665x and 5666x, 260 mm, Black



Item no.: 77109

260 mm

5 Pcs.

Material: Cellular rubber (oil resistant); Polypropylene (regenerated material)

Hygienic Hand Squeegee w/replacement cassette, 250 mm



FDA
Item no.: 7711

250 mm

121 °C

20 Pcs.

Material: Polypropylene; TPE Rubber

Hygienic Floor Squeegee w/replacement cassette, 400 mm

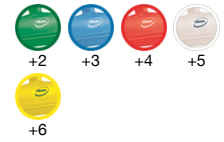

FDA
Item no.: 7712

400 mm

121 °C

10 Pcs.

Material: Polypropylene; TPE Rubber

Hygienic Floor Squeegee w/replacement cassette, 500 mm

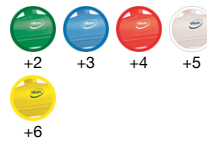

FDA
Item no.: 7713

500 mm

121 °C

10 Pcs.

Material: Polypropylene; TPE Rubber

Hygienic Floor Squeegee w/replacement cassette, 600 mm

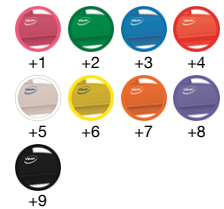

FDA
Item no.: 7714

600 mm

121 °C

10 Pcs.

Material: Polypropylene; TPE Rubber

Hygienic Floor Squeegee w/replacement cassette, 700 mm

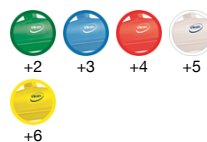

FDA
Item no.: 7715

700 mm

121 °C

10 Pcs.

Material: Polypropylene; TPE Rubber

Condensation squeegee, 400 mm

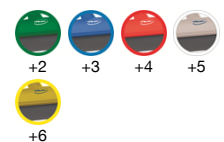

Item no.: 7716

400 mm

121 °C

3 Pcs.

Material: Polypropylene; TPE Rubber

Hygienic Revolving Neck Squeegee
w/replacement cassette, 405 mm

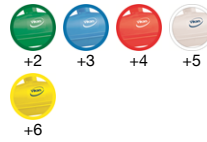

FDA
Item no.: 7722

405 mm

121 °C

10 Pcs.

Material: Polypropylene; TPE Rubber

Hygienic Revolving Neck Squeegee
w/replacement cassette, 600 mm

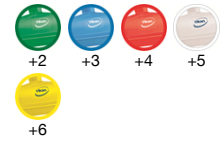

FDA
Item no.: 7724

600 mm

121 °C

10 Pcs.

Material: Polypropylene; TPE Rubber

Replacement Cassette, Hygienic, 250 mm,

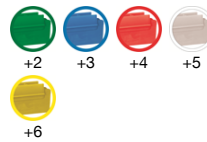

FDA
Item no.: 7731

250 mm

121 °C

20 Pcs.

Material: Polypropylene; TPE Rubber

Replacement Cassette, Hygienic, 400 mm,

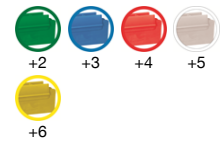

FDA
Item no.: 7732

400 mm

121 °C

20 Pcs.

Material: Polypropylene; TPE Rubber

Replacement Cassette, Hygienic, 500 mm,

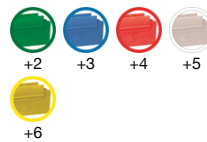

FDA
Item no.: 7733

500 mm

121 °C

20 Pcs.

Material: Polypropylene; TPE Rubber

Replacement Cassette, Hygienic, 600 mm,

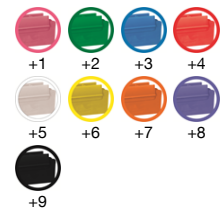

FDA
Item no.: 7734

600 mm

121 °C

20 Pcs.

Material: Polypropylene; TPE Rubber

Replacement Cassette, Hygienic, 700 mm,





+2

+3



+4

+5



+6



Item no.: 7735



700 mm



121 °C



20 Pcs.

Material: Polypropylene; TPE Rubber

Hand Squeegee w/Replacement Cassette, 250 mm



+2

+3

+4

+5

+6

Item no.: 7751



250 mm



90 °C





20 Pcs.

Material: Polypropylene; Cellular rubber

Floor squeegee w/Replacement Cassette, 400 mm





+2



+3

+4



+5

+6

Item no.: 7752



400 mm





10 Pcs.

Material: Polypropylene; Cellular rubber

Floor squeegee w/Replacement Cassette, 500 mm





+2

+3



+4

+5



+6

+9

Item no.: 7753



500 mm



10 Pcs.

Material: Polypropylene; Cellular rubber

Floor squeegee w/Replacement Cassette, 600 mm



+1

+2

+3

+4

+5

+6

+7

+8

+9

+66

+77

+88

Item no.: 7754



600 mm





10 Pcs.

Material: Polypropylene; Cellular rubber

Floor squeegee w/Replacement Cassette, 700 mm





+2



+3

+4



+5

+6

Item no.: 7755



700 mm



10 Pcs.

Material: Polypropylene; Cellular rubber

Revolving Neck Floor squeegee
w/Replacement Cassette, 400 mm



Item no.: 7762

400 mm

10 Pcs.

Material: Polypropylene; Cellular rubber

Revolving Neck Floor squeegee
w/Replacement Cassette, 500 mm



Item no.: 7763

500 mm

10 Pcs.

Material: Polypropylene; Cellular rubber

Revolving Neck Floor squeegee
w/Replacement Cassette, 600 mm



Item no.: 7764

600 mm

10 Pcs.

Material: Polypropylene; Cellular rubber

Replacement Cassette, 250 mm, White



Item no.: 77715

250 mm

90 °C

20 Pcs.

Material: Polypropylene; Cellular rubber

Replacement Cassette, 400 mm

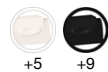

Item no.: 7772

400 mm

90 °C

20 Pcs.

Material: Polypropylene; Cellular rubber

Replacement Cassette, 500 mm



Item no.: 7773

500 mm

90 °C

20 Pcs.

Material: Polypropylene; Cellular rubber

Replacement Cassette, 600 mm



Item no.: 7774

600 mm

20 Pcs.

Material: Polypropylene; Cellular rubber

Replacement Cassette, 700 mm



Item no.: 7775

700 mm

20 Pcs.

Material: Polypropylene; Cellular rubber





Scrapers

Scrape any surface free of stubborn debris with our extensive range of effective scrapers. Available with steel, flexible polypropylene blades, and temperature resistant nylon.

These scrapers remove sticky, oily, baked on, dried and other debris from work surfaces, conveyor belts, floors, tables, cookers, hard-to-reach areas and even curved equipment.

- Stainless steel scrapers are great for removing stubborn debris from tough surfaces, like tiles, and hot and cold surfaces. They come in a range of blade sizes, to facilitate everything from work surface to floor cleaning, and can be fitted to any Vikan handle to provide the length required.
- Plastic scrapers can be used on surfaces where a stainless steel blade might damage the surface being scraped. They are available in a range of colours, and come in handheld and threaded handle versions for extendibility.
- Nylon scrapers allow the scraping of very hot and very cold surfaces.
- Flexible plastic scrapers are available in metal detectable versions.
- Paddles scrapers are available in nylon and polyethylene.

Table & Floor Scraper, 245 mm





  Item no.: 2908	 31 mm	 121 °C	 10 Pcs.
---	--	---	--

Material: Polypropylene; Stainless Steel (AISI 304)

Scraper w/flexible steelblade, 260 mm





  Item no.: 2909	 260 mm	 121 °C	 10 Pcs.
---	---	---	--

Material: Polypropylene; Stainless Steel (AISI 301)

Table & Floor Scraper, 260 mm





  Item no.: 2910	 260 mm	 121 °C	 10 Pcs.
---	---	---	--

Material: Polypropylene; Stainless Steel (AISI 304)

Nylon Table & Floor Scraper, 255 mm

NEW





   Item no.: 2911	 33 mm	 121 °C	 5 Pcs.
---	--	---	---

Material: Nylon

Table- & Floor Scraper, 270 mm, White



   Item no.: 29125	 270 mm	 121 °C	 10 Pcs.
--	---	---	--

Material: Polyamide

Stainless Steel Hand Scraper, 50 mm





  Item no.: 4008	 50 mm	 121 °C	 10 Pcs.
---	--	---	--

Material: Polypropylene; Stainless Steel (AISI 301)

Stainless Steel Hand Scraper, 100 mm



FDA
Item no.: 4009

100 mm

121 °C

10 Pcs.

Material: Polypropylene; Stainless Steel (AISI 301)

Stainless Steel Scraper with Threaded Handle, 50 mm

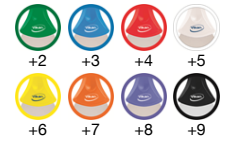

FDA
Item no.: 4010

50 mm

121 °C

10 Pcs.

Material: Polypropylene; Stainless Steel (AISI 301)

Stainless Steel Scraper with Threaded Handle, 100 mm



FDA
Item no.: 4011

100 mm

121 °C

10 Pcs.

Material: Polypropylene; Stainless Steel (AISI 301)

Nylon Scraper with Threaded Handle, 100 mm

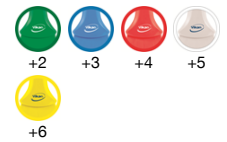

FDA
Item no.: 4012

100 mm

121 °C

10 Pcs.

Material: Nylon; Polypropylene

Nylon Hand Scraper, 100 mm

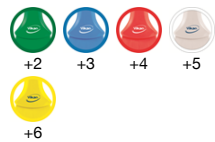

FDA
Item no.: 4013

100 mm

121 °C

10 Pcs.

Material: Nylon; Polypropylene

Hand Scraper, flexible, 165 mm



FDA
Item no.: 4051

165 mm

121 °C

10 Pcs.

Material: Polypropylene

Hand Scraper, flexible, Metal Detectable, 165 mm



- +2
- +3
- +4
- +5
- +6

Item no.: 4052

165 mm

121 °C

10 Pcs.

Material: Polypropylene; Metal & X-Ray detectable additive

Dough Cutter/Scraper, Stainless Steel Blade, Flexible, 146 mm



- +2
- +3
- +4
- +5
- +6
- +7

Item no.: 4057

30 mm

5 Pcs.

Material: Polypropylene; Stainless Steel (AISI 304)

Hand Scraper, 75 mm



- +1
- +2
- +3
- +4
- +5
- +6
- +7
- +8
- +9
- +66
- +77
- +88

Item no.: 4060

18 mm

121 °C

10 Pcs.

Material: Polypropylene

Hand Scraper, 102 mm



- +2
- +3
- +4
- +5
- +6

Item no.: 4061

18 mm

121 °C

10 Pcs.

Material: Polypropylene

Hand Scraper, Metal Detectable, 75 mm



- +2
- +3
- +4
- +5
- +6

Item no.: 4062

18 mm

121 °C

10 Pcs.

Material: Polypropylene; Metal & X-Ray detectable additive

Hand Scraper, Metal Detectable, 102 mm



- +2
- +3
- +4
- +5
- +6

Item no.: 4063

18 mm

121 °C

10 Pcs.

Material: Polypropylene; Metal & X-Ray detectable additive

Push-Pull Hoe, 270 mm, Blue

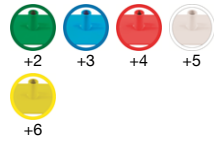

FDA
Item no.: 5900

270 mm

121 °C

175 °C

5 Pcs.

Material: Polyamide





Handles

Every head needs a handle and at Vikan our range of handles is nearly as comprehensive as the heads they are designed to fit on to. Whether you need a plastic, stainless steel, aluminium or wooden handle, or one that's hygienically designed, short, long, telescopic, water-fed, or colour-coded, we are sure to have one that suits your needs.

- Ultra Hygienic handles, primarily designed for use with the Colour-coded product range, are available in a range of colours, and lengths, are fully moulded and easy to clean. The Ultra Hygienic handles compliment the UST broom range and Ultra Hygiene squeegees perfectly.
- The Ultra Hygienic Mini handles are ideal for use with any hand held Vikan product.
- The lightweight, ergonomically designed aluminium handles minimise the risk of occupational injury and the water-fed versions feature quick-release hose connections and insulated sleeves for a comfortable grip. Suitable for use with our Colour-coded, Microfibre and Transport product ranges.
- The ridged stainless steel handles are strong, durable, chemical resistant and suitable for use with our Colour-coded products.
- The flexible stainless-steel and nylon handles mounted on our twisted wire brush heads facilitate cleaning of curved pipework.
- Telescopic handles enable cleaning at height of remote surfaces more easily and effectively.
- Vikan's top adjustable handle, featuring a button on the handle head that allows quick and easy adjustment of the handle length, is uniquely designed for use with our Microfibre product range.
- Our traditional high quality wooden handle range are exclusively designed for use with our Classic range of products.

Bottle for condensed water, 0.5 Litre,
1/2" (Q)



Item no.: 11005



100 mm



0.5 Litre(s)



3 Pcs.

Material: Polyethylene (HDPE); Chromium-plated brass; Galvanized steel (S235); Synthetic rubber

Mini-Handle, 160 mm,

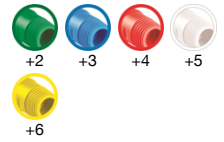

Item no.: 2934



160 mm



30 mm



121 °C



10 Pcs.

Material: Polypropylene

Aluminium Telescopic handle, 1305 - 1810
mm, Ø32 mm, White



Item no.: 29255

Material:

Anodised Aluminium; Polypropylene



32 mm



1305 mm



5 Pcs.

Aluminum Handle, Ø22 mm, 840 mm

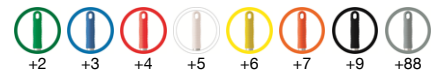

Item no.: 2931

Material:

Anodised Aluminium; Polypropylene



22 mm



840 mm



121 °C



10 Pcs.

Aluminum Handle, 1310 mm,



FDA
Item no.: 2935

Material:
Anodised Aluminium; Polypropylene

31 mm

1310 mm

121 °C

10 Pcs.

Aluminum Handle, 1510 mm,



FDA
Item no.: 2937

Material:
Anodised Aluminium; Polypropylene

31 mm

1510 mm

121 °C

10 Pcs.

Stainless Steel Handle, Ø31 mm, 1510 mm



FDA
Item no.: 2939

Material:
Stainless Steel (AISI 304); Polypropylene

31 mm

1510 mm

121 °C

5 Pcs.

Aluminum Handle, Ø25 mm, 1260 mm



FDA
Item no.: 2958

Material:
Anodised Aluminium; Polypropylene

25 mm

1260 mm

10 Pcs.

Aluminum Handle, Ø25 mm, 1460 mm



FDA
Item no.: 2959

Material:
Anodised Aluminium; Polypropylene

25 mm

1460 mm

10 Pcs.

Ultra Hygienic Handle, Ø32 mm, 1300 mm



FDA
Item no.: 2960

Material:
Polypropylene; Glass reinforced

32 mm

1300 mm

121 °C

10 Pcs.

Ultra Hygienic Handle, Ø32 mm, 1500 mm



<p>Item no.: 2962</p>	<p>Material: Polypropylene; Glass reinforced</p>	<p>32 mm</p>	<p>1500 mm</p>	<p>121 °C</p>	<p>10 Pcs.</p>
-----------------------	--	--------------	----------------	---------------	----------------

Ultra Hygienic Handle, Ø32 mm, 1700 mm

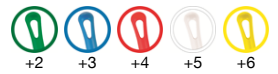

<p>Item no.: 2964</p>	<p>Material: Polypropylene; Glass reinforced</p>	<p>32 mm</p>	<p>1700 mm</p>	<p>121 °C</p>	<p>10 Pcs.</p>
-----------------------	--	--------------	----------------	---------------	----------------

Ultra Hygienic Handle, Ø32 mm, 650 mm

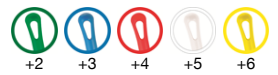

<p>Item no.: 2966</p>	<p>Material: Polypropylene; Glass reinforced</p>	<p>32 mm</p>	<p>650 mm</p>	<p>121 °C</p>	<p>10 Pcs.</p>
-----------------------	--	--------------	---------------	---------------	----------------

Ultra Hygienic Handle, Ø32 mm, 1000 mm



 Item no.: 2968	Material: Polypropylene; Glass reinforced	 32 mm	 1000 mm	 121 °C	 10 Pcs.
--------------------	--	-----------	-------------	------------	-------------

Aluminum Telescopic Handle w/Hose Nozzle, waterfed, 1615 - 2780 mm, Ø32 mm, White



 Item no.: 29735	Material: Anodised Aluminium; Polypropylene; Chromium-plated brass	 32 mm	 1615 mm	 5 Pcs.	 6 Bar
---------------------	---	-----------	-------------	------------	-----------





Aluminum Telescopic Handle, waterfed, w/Metal Nozzle (Q), 1600 - 2780 mm, Ø32 mm



 Item no.: 2973Q	Material: Anodised Aluminium; Polypropylene; Chromium-plated brass	 32 mm	 1600 mm	 5 Pcs.	 6 Bar
---------------------	---	-----------	-------------	------------	-----------



Aluminum Telescopic handle, 1575 - 2780 mm, Ø32 mm



 Item no.: 2975	Material: Anodised Aluminium; Polypropylene	 32 mm	 1575 mm	 121 °C	 5 Pcs.
--	--	--	--	---	---



Telescopic handle, Fibre Glass, Thread, 1880 - 6000 mm, Ø34 mm, Grey



Item no.: 2977	Material: Fibreglass; Polypropylene	 1880 mm	 6000 mm	 1 Pcs.
-------------------	--	--	--	---

Fibre Glass Telescopic Handle only for Condensation Squeegee 7716x (Q), 1880 - 6000 mm, Ø34 mm, Grey



Item no.: 2977Q	Material: Fibreglass; Polypropylene; Chromium-plated brass	 1880 mm	 6000 mm	 1 Pcs.
--------------------	---	--	--	---

Stainless Steel Handle, Ø31 mm, 1025 mm



FDA
Item no.: 2983

Material:
Stainless Steel (AISI 304); Polypropylene

31 mm

1025 mm

121 °C

5 Pcs.

Aluminum Handle w/Metal Nozzle, waterfed (Q), Ø31 mm, 1540 mm, White



FDA
Item no.: 2991Q5

Material:
Anodised Aluminium; Polypropylene; Chromium-plated brass

31 mm

1540 mm

10 Pcs.

Adapter, Ø25 mm, 85 mm, White



FDA
Item no.: 29955

85 mm

25 mm

121 °C

10 Pcs.

Material: Polypropylene

Flexible extension handle f/53515, Ø5 mm, 812 mm



FDA  Item no.: 5346

Material:
Stainless Steel (AISI 303); Stainless Steel (AISI 304Cu); Stainless Steel (AISI 303Cu)

 5 mm

 812 mm

 121 °C

 10 Pcs.

Flexible Handle, stainless steel, Ø5 mm, 755 mm, White



FDA  Item no.: 53515

Material:
Stainless Steel (AISI 304); Polypropylene; Stainless Steel (AISI 303Cu)

 5 mm

 755 mm

 121 °C

 10 Pcs.

Flexible handle, Nylon, Ø6 mm, 1505 mm, White



FDA  Item no.: 53525

Material:
Polypropylene; Stainless Steel (AISI 303Cu); POM

 6 mm

 1505 mm

 121 °C

 10 Pcs.



Scoops

Scoop wet or dry ingredients with hygienically designed Vikan scoops. These scoops feature smooth, easy-to-clean surfaces and a one-piece construction that eliminates areas where contamination can gather.

- Available in a wide range of shapes and sizes.
- Lightweight, durable and ergonomically designed.
- Hygienically designed for food handling applications.
- Available in a range of food contact compliant colours to allow for easy segregation of use, particularly with regard to ingredients and allergen segregation.
- Also available in metal detectable versions.

Kit for metal detection, 55 mm, Blue

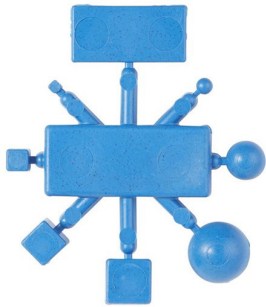

FDA
Item no.: 11113

55 mm

5 Pcs.

Material: Polypropylene; Metal & X-Ray detectable additive

Hand Scoop, Metal Detectable, 2 Litre

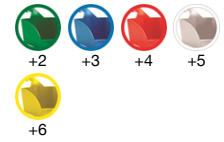

FDA
Item no.: 5667

390 mm

2 Litre(s)

121 °C

10 Pcs.

Material: Polypropylene; Metal & X-Ray detectable additive

Hand Scoop, Metal Detectable, 1 Litre

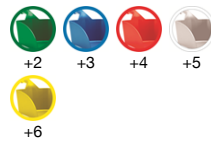

FDA
Item no.: 5668

1 Litre(s)

121 °C

12 Pcs.

Material: Polypropylene; Metal & X-Ray detectable additive

Hand Scoop, Metal Detectable, 0.5 Litre

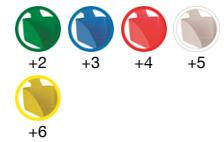

FDA
Item no.: 5669

310 mm

0.5 Litre(s)

121 °C

15 Pcs.

Material: Polypropylene; Metal & X-Ray detectable additive

Hand Scoop, 2 Litre

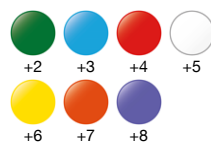

FDA
Item no.: 5670

390 mm

2 Litre(s)

121 °C

10 Pcs.

Material: Polypropylene

Ergonomic scoop, 2 Litre

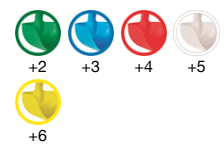

FDA
Item no.: 5671

270 mm

2 Litre(s)

121 °C

10 Pcs.

Material: Polypropylene

Hand Scoop, 1 Litre

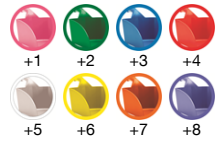

FDA
 Item no.: 5675

350 mm

1 Litre(s)

121 °C

12 Pcs.

Material: Polypropylene

Hand Scoop, 0.5 Litre



FDA
 Item no.: 5677

310 mm

0.5 Litre(s)

121 °C

15 Pcs.

Material: Polypropylene

Round Bowl Scoop, 1 Litre



FDA
 Item no.: 5681

295 mm

1 Litre(s)

121 °C

10 Pcs.

Material: Polypropylene

Round Bowl Scoop, 2 Litre

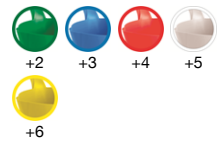

FDA
 Item no.: 5682

330 mm

2 Litre(s)

121 °C

10 Pcs.

Material: Polypropylene

Measuring jug, 2 Litre

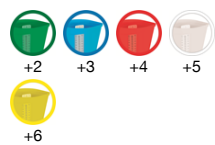

FDA
 Item no.: 6000

172 mm

2 Litre(s)

121 °C

10 Pcs.

Material: Polypropylene



Shovels, forks and rakes

Ergonomically designed Vikan shovels, forks and rakes come in various sizes and shapes for almost any application – including food handling.

The shovels can be used for moving large amounts of ingredients waste or even snow.

- Lightweight, durable and ergonomically designed.
- Some shovels feature holes for rapid liquid drainage.
- The shovel is available in a metal-detectable version.
- Hygienic fork available for emptying fresh produce from large containers during harvest.

Ergonomic shovel, 1310 mm

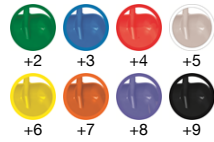

Item no.: 5601		1310 mm	121 °C	380 x 340 x 90 mm	1 Pcs.

Material: Polypropylene; Anodised Aluminium

Ergonomic shovel with drain holes, 1145 mm, Blue

NEW



Item no.: 56033		1145 mm	121 °C	380 x 340 x 90 mm	1 Pcs.

Material: Polypropylene; Anodised Aluminium

Ergonomic shovel with drain holes, 1145 mm, White



Item no.: 56035		1145 mm	121 °C	380 x 340 x 90 mm	1 Pcs.

Material: Polypropylene; Anodised Aluminium

Ergonomic shovel with drain holes, 1310 mm, Black



Item no.: 56049		1310 mm	121 °C	380 x 340 x 90 mm	1 Pcs.

Material: Polypropylene; Anodised Aluminium

Ergonomic shovel, 1280 mm

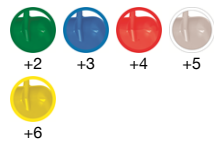

Item no.: 5611		1280 mm	121 °C	340 x 270 x 75 mm	1 Pcs.

Material: Polypropylene; Anodised Aluminium

Shovel, D Grip, 1035 mm, Blue

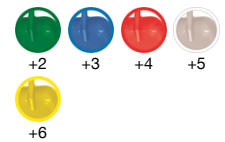

Item no.: 5623		1035 mm	121 °C	379 x 345 x 90 mm	5 Pcs.

Material: Polypropylene

Shovel, D Grip, 1040 mm, Blue



FDA
Item no.: 5625



1040 mm

121 °C

327 x 271 x 50 mm

5 Pcs.

Material: Polypropylene

Shovel, Metal Detectable, D Grip, 1040 mm, Blue

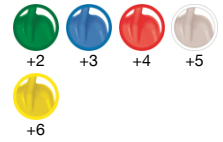

FDA
Item no.: 5626



1040 mm

121 °C

327 x 271 x 50 mm

5 Pcs.

Material: Polypropylene; Metal & X-Ray detectable additive

Shovel, T-Grip, 1035 mm, Orange



FDA
Item no.: 56317



1035 mm

121 °C

327 x 271 x 50 mm

5 Pcs.

Material: Polypropylene

Hand shovel, 275 mm, Blue



FDA
Item no.: 5673



550 mm

121 °C

327 x 271 x 50 mm

12 Pcs.

Material: Polypropylene

Hand shovel, Metal Detectable, 275 mm, Blue



FDA
Item no.: 5674



550 mm

121 °C

327 x 271 x 50 mm

12 Pcs.

Material: Polypropylene; Metal & X-Ray detectable additive

Hygiene Fork, 1275 mm, White



FDA
Item no.: 56905



1275 mm

121 °C

1 Pcs.

Material: Polypropylene

Hygiene Rake, 205 mm, White



Item no.: 56915



205 mm



121 °C



1 Pcs.

Material: Polypropylene





Mixers

Vikan offers a wide variety of mixers, stirrers and paddles, manufactured in food contact compliant plastic or nylon, designed for virtually every processing application.

- Both excellent for mixing all liquids and viscous products.
- Nylon stirrer is good for use with hot foods and liquids.
- Fully moulded, one-piece construction is easy to clean.
- Also feature a scraping edge to help remove product from the sides of mixing vessels.
- Available in versions with holes that allow the ingredients to pass through the blade and ease stirring.

Mixer, Small Blade, Ø31 mm, 890 mm, White



FDA
Item no.: 70075

890 mm

31 mm

121 °C

1 Pcs.

Material: Polyamide

Mixer, Large Blade, Ø31 mm, 1180 mm, White



FDA
Item no.: 70095

1180 mm

31 mm

121 °C

1 Pcs.

Material: Polyamide

Mixer, Ø31 mm, 1190 mm, White



FDA
Item no.: 70105

1190 mm

31 mm

121 °C

1 Pcs.

Material: Polypropylene

Paddle Scraper Blade, 220 mm, White



FDA
Item no.: 70115

220 mm

121 °C

10 Pcs.

Material: Polyamide

Mixer w/Holes, Ø31 mm, 1200 mm, White



FDA
Item no.: 70125

1200 mm

31 mm

121 °C

1 Pcs.

Material: Polypropylene

Paddle Scraper Blade, Flexible, 210 mm

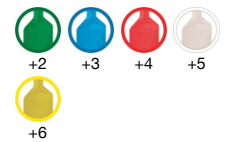

FDA
Item no.: 7013

210 mm

10 Pcs.

Material: Polyethylene (LDPE)

Mixer w/Holes, Metal Detectable, Ø31 mm, 1200 mm



FDA
Item no.: 7014

1200 mm

31 mm

121 °C

1 Pcs.

Material: Polypropylene; Metal & X-Ray detectable additive



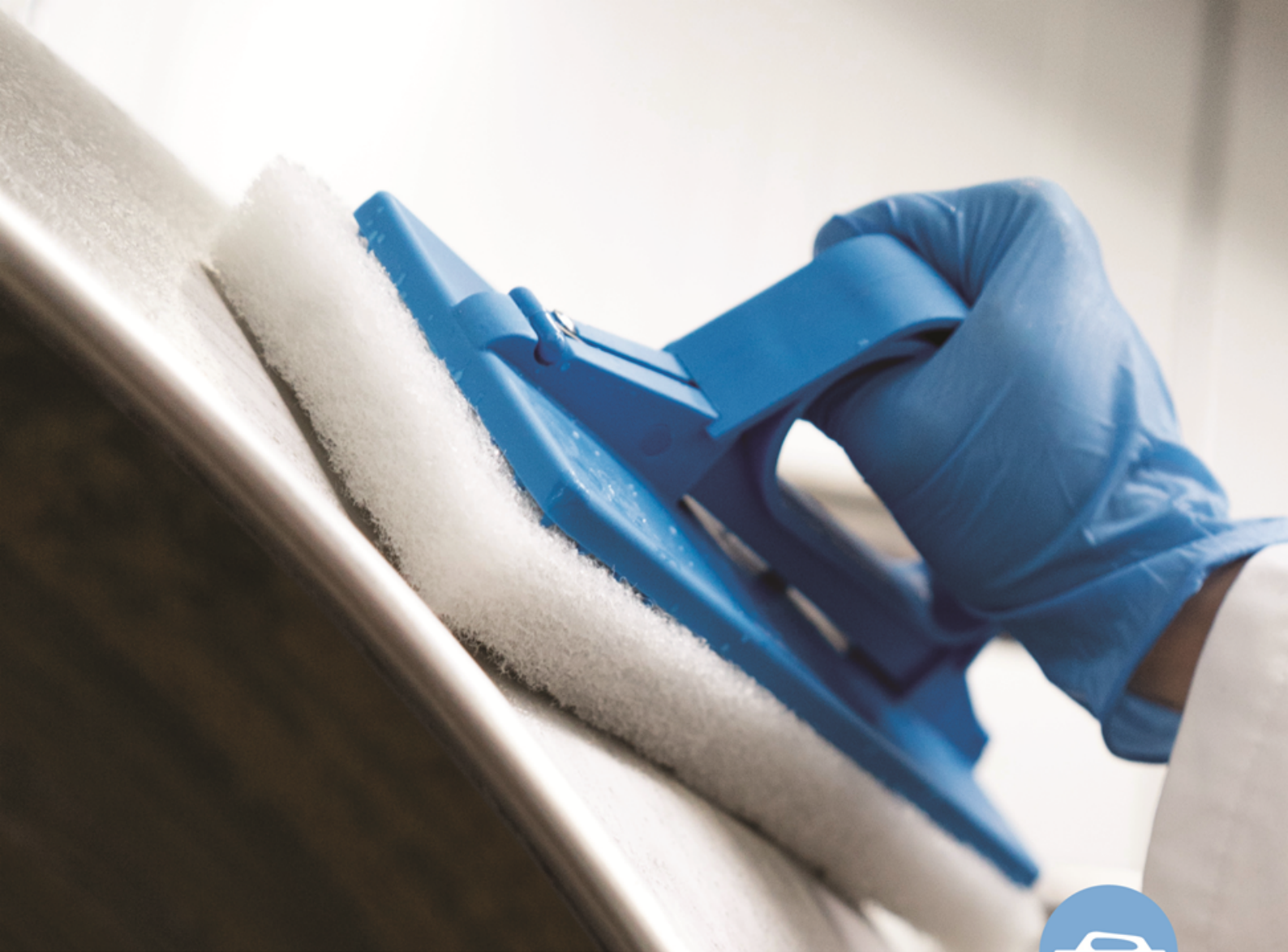

Scouring pads and holders

Vikan scouring pads and holders are suitable for a wide range of industries and specific applications. Our scouring pads are highly effective and durable. Vikan handheld and extendable pad holders come in a range of sizes and colours and feature a secure locking system that keeps the pad firmly in place.

We also offer wash fleece products for selected applications.

- Scouring pads are effective and long-lasting.
- Pads available in colour-coded varieties: white for soft, blue for medium and brown for hard.
- Pad holder features locking system that keeps the scouring pad in place.
- Wash fleece and holder options.

Padholder, 230 mm

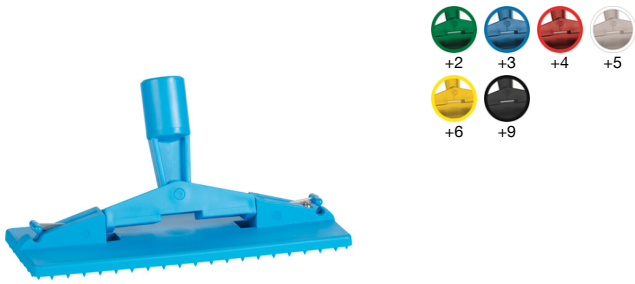

Item no.: 5500



230 mm



121 °C



10 Pcs.

Material: Polypropylene; Stainless Steel (AISI 304); Nylon

Padholder Hand model, 230 mm



Item no.: 5510



230 mm



121 °C



10 Pcs.

Material: Polypropylene; Stainless Steel (AISI 304); Nylon

Pad, stiff, 245 mm, Hard, Brown



Item no.: 5523



245 mm



100 °C



10 Pcs.

Material: 100% Polyester (Microfibre)

Pad, Medium, 245 mm, Medium, Blue



Item no.: 5524



245 mm



100 °C



10 Pcs.

Material: 100% Polyester (Microfibre)

Pad, soft, 245 mm, Soft, White



Item no.: 5525



245 mm



100 °C



10 Pcs.

Material: 100% Polyester (Microfibre)



Dustpan set & dusters

Collect debris of any kind and dust from floors and work surfaces using Vikan's range of dustpans, dustpan sets and dusters.

- Colour-coded, food-contact-compliant dustpans with fully aligned edge make sure all dust and debris are collected.
- Long-handled dustpans eliminate the need to bend over or kneel.
- Dusters available with telescopic handles.
- Wool and microfibre dusters available.
- Colour coded Closable Dustpan Set complete with angle cut bristle broom, for ergonomic, all-in-one sweeping.

Dustpan, 295 mm



+1	+2	+3	+4
+5	+6	+7	+8
+9	+66	+77	+88

FDA	Recycling	330 mm	121 °C	10 Pcs.
-----	-----------	--------	--------	---------

Material: Polypropylene

Upright Dustpan, 330 mm



+2	+3	+4	+5
+6	+7	+8	+9
+88			

FDA	Recycling	330 mm	121 °C	10 Pcs.
-----	-----------	--------	--------	---------

Material: Polypropylene; Polyamide; Anodised Aluminium

Dustpan set, closable with broom, 350 mm, Medium



+2	+3	+4	+5
+6	+7	+9	+88

FDA	Recycling	160 mm	4 Pcs.
-----	-----------	--------	--------

Material: Anodised Aluminium; Polypropylene; Polyester (PBT); Stainless Steel (AISI 304)

Upright Dustpan and Broom Set, 330 mm, Medium

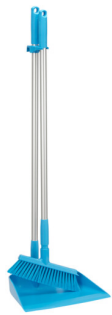

+2	+3	+4	+5
+6	+7	+9	+88

FDA	Recycling	330 mm	121 °C	10 Pcs.
-----	-----------	--------	--------	---------

Material: Polypropylene; Anodised Aluminium; Polyamide; Polyester (PBT)





HyGo

HyGo from Vikan is the food and beverage industry's first mobile cleaning station to combine hygiene, efficiency, and manoeuvrability in a purpose-built solution.

- HyGo combines industry feedback and Vikan's own experience, making it the ideal compact solution to organise and transport sanitation tools in food production, food service, and retail environments.
- HyGo is durable and designed with cleanability in mind. Smooth, drainable surfaces, and minimal harborage points reduce the risk of contamination.
- Beyond elevating sanitation efforts, HyGo also conquers space challenges, lost equipment, and wasted time. With a fleet of customisable HyGos on the production floor, tools stay organised and get to where they are needed quickly.
- HyGo is also available in six colours to support your colour-coding programs.

Rail for HyGo Cleaning Station, 5700x, 420 mm

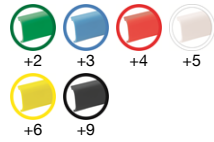

FDA
Item no.: 1005

420 mm

10 Pcs.

Material: Polypropylene

Hook for HyGo Mobile Cleaning Station, 5700x (2 pcs), 90 mm



FDA
Item no.: 1008

90 mm

5 Pcs.

Material: Polyamide

HyGo Mobile Cleaning Station, 780 mm



Item no.: 5700

780 mm

530 mm

1030 mm

1 Pcs.

Material: Polypropylene; Stainless Steel (AISI 301); Stainless Steel (AISI 304); Brass; TPE Rubber; Polyamide

HyGo Waste Bag Holder Kit, 470 mm, Grey

NEW



Item no.: 579018

1 Pcs.

Material: Polypropylene; Polyamide; POM

Castor for HyGo, 5700x without Brake, Ø125mm, Black



Item no.: 98109

5 Pcs.

Material: Polypropylene; Thermoplastic Vulkanisate (TPV)

Castor for HyGo, 5700x with Brake, Ø125mm, Black



Item no.: 98119

5 Pcs.

Material: Polypropylene; Thermoplastic Vulkanisate (TPV)



Foaming equipment

At Vikan, we offer foaming equipment for use on different surfaces in a variety of industries. Versatile, effective and with minimal generation of aerosols, these tools are used to clean everything from food service areas to changing rooms at sports facilities and even swimming pools. They work purely with the pressure from your water supply system.

- Sprayers feature functional design with continually variable water supply.
- Ergonomically designed.
- Foam is applied without generating aerosols.
- Colour coding facilitates chemical identification.

Foam sprayer, incl. jet spray, 1/2"(Q), 2.5 Litre



Item no.: 9303

2.5 Litre(s)

1 Pcs.

8 Bar

2 Bar

Material: Brass; Orgalloy; Polyamide; Polyethylene (HDPE)

Foam sprayer incl. jet spray, 1/2"(Q), 1.4 Litre



Item no.: 9305

1.4 Litre(s)

1 Pcs.

6 Bar

2 Bar

Material: Brass; Polyamide; Polyethylene (HDPE)

Spare container, 1.4 Litre

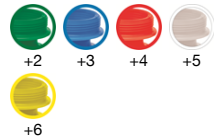

Item no.: 9310

4 Pcs.

10 Bar

Material: Polyethylene (HDPE)

Spare container, 2.5 Litre



Item no.: 9311

4 Pcs.

10 Bar

Material: Polyethylene (HDPE)

Ergo injector with suction hose for 9303x, 1/2" (Q), Black



Item no.: 93139

1 Pcs.

10 Bar

Material: PVC; Polystyrene; Polypropylene

Injector with suction hose, 1/2" (Q), Black



Item no.: 93149

5 Pcs.

10 Bar

Material: Chromium-plated brass; PVC; Polypropylene

Suction hose for injector, 93139 & 93149, 220 mm, White



Item no.: 93175

10 Pcs.

10 Bar

Material: PVC

Plastic lid for container 9310x and 9311x, Black



Item no.: 93189

4 Pcs.

Material: Vinyl

Combi watergun for foam sprayer 1/2"(Q), Black



Item no.: 93209

4 Pcs.

6 Bar

Material: Polyamide; Chromium-plated brass

Watergun for Foam Sprayer 1/2"(Q), Black



Item no.: 93239

1 Pcs.

8 Bar

Material: Polyamide; Polypropylene; Chromium-plated brass

SafeOne, Back Flow Prevention, 1/2" (Q)



Item no.: 9341

8 Pcs.

25 Bar

Material: Chromium-plated brass

Stainless steel suspension for foam sprayer, 9303x/9305x



Item no.: 9348

1 Pcs.

Material: Stainless Steel (AISI 316)

Jet spray plastic for 93209 and 93239, 1/2" (Q)



Item no.: 9350



10 Pcs.



10 Bar

Material: Glass reinforced; Nylon

Angled jet spray, small nozzle, 1/2" (Q)



Item no.: 9352



5 Pcs.



12 Bar

Material: Anodised Aluminium; Brass

Adjustable nozzle, 1/2" (Q)



Item no.: 9354



10 Pcs.



25 Bar

Material: Orgalloy; Chromium-plated brass

Set of nozzles for 9303x and 9305x (0.4-10%)



Item no.: 9378



1 Pcs.

Material: Polypropylene

Outlet hose, 1500 mm, 1/2" (Q)



Item no.: 94415



15 Pcs.



20 Bar

Material: PVC; Chromium-plated brass



Couplings

Vikan offers high-quality couplings that make attaching and changing hoses and sprayers quick and easy.

- Couplings come in ½" and ¾" sizes.
- Quick Fit couplings are designed to make changing spraying equipment more easy and efficient.
- Quick fit couplings are designed to make it easier to mount hoses on water taps, handles and foaming equipment.

Hose Nozzle, 1/2" & 3/4"



Item no.: 0708



10 Pcs.



25 Bar

Material: Chromium-plated brass; Synthetic rubber

Quick Fit Hose Coupling with 1/2" thread for 9324x, 3/4"(Q)



Item no.: 0715



10 Pcs.



25 Bar

Material: Chromium-plated brass; Synthetic rubber

Water Tap Nozzle with 1/2", 3/4" & M22 Internal Thread, 1/2"(Q)



Item no.: 880700



10 Pcs.



25 Bar

Material: Chromium-plated brass; Synthetic rubber

Hose Coupling, 1/2" (Q)



Item no.: 880701



10 Pcs.



25 Bar

Material: Chromium-plated brass; Galvanized steel (DIN 1.09035); Synthetic rubber

Coupling with Hose Nozzle and Shut-Off Valve, 1/2" (Q)



Item no.: 880703



10 Pcs.



25 Bar

Material: Chromium-plated brass; Galvanized steel (DIN 1.09035)

Male Connector/Nozzle, 1/2" (Q)



Item no.: 880705



10 Pcs.



25 Bar

Material: Chromium-plated brass

Nozzle with 1/2" thread for 1/2" & 3/4" Water Hose



Item no.: 880708



10 Pcs.



25 Bar

Material: Chromium-plated brass; Synthetic rubber

Nozzle with 1/2" thread for 9324x, 1/2" (Q)



Item no.: 880712



10 Pcs.



25 Bar

Material: Chromium-plated brass; Synthetic rubber

Nozzle with 1/2" thread for 9324x, 3/4" (Q)



Item no.: 880715



10 Pcs.



25 Bar

Material: Chromium-plated brass; Synthetic rubber

Hose coupling, 3/4" (Q)



Item no.: 880716



10 Pcs.



25 Bar

Material: Chromium-plated brass; Galvanized steel (DIN 1.09035); Synthetic rubber

Hose Coupling, 1/2"(C)



Item no.: 881701



10 Pcs.



25 Bar

Material: Chromium-plated brass; Galvanized steel (DIN 1.09035); Synthetic rubber



Water guns & hoses

We offer water guns and hoses for use in a variety of industries and applications. Versatile and effective, our water guns are used to clean everything from food service areas to changing rooms at sports facilities and even swimming pools. Our hoses are designed for use with hot or cold water, and come in 1/2" couplings and various lengths.

- Gun sprayers feature functional design with continually variable water pressure.
- Water guns available with angled jets to hit hard-to-reach places.
- Cold water hoses can be used with water up to 40 degrees Celsius.
- Hot water hoses are designed for use with water up to 70 degrees Celsius.

Spraying gun 1/2" (Q), Black



Item no.: 93229

4 Pcs.

6 Bar

Material: Chromium-plated brass; Polyamide

Heavy Duty Water Gun

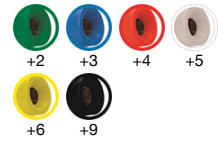

Item no.: 9324

1 Pcs.

24 Bar

Material: Brass; EPDM rubber; Stainless Steel (AISI 304)

Cold water hose, 1/2" (Q), 10000 mm, Transparent



Item no.: 93315

1/2"

1 Pcs.

12 Bar

Material: PVC; Chromium-plated brass; Polyester (PBT)

Cold water hose, 1/2" (Q), 15000 mm, Transparent



Item no.: 93325

1/2"

1 Pcs.

12 Bar

Material: PVC; Chromium-plated brass; Polyester (PBT)

Hot Water Hose, 1/2" (Q), 10000 mm, Blue



Item no.: 93353

1/2"

1 Pcs.

20 Bar

Material: PVC; Chromium-plated brass

Hot Water Hose, 1/2" (Q), 15000 mm, Blue



Item no.: 93363

1/2"

1 Pcs.

20 Bar

Material: PVC; Chromium-plated brass

Hot Water Hose, 1/2" (Q), 20000 mm, Blue



Item no.: 93373



1/2"



1 Pcs.



20 Bar

Material: PVC; Chromium-plated brass

Stainless steel hose suspension



Item no.: 9345



1 Pcs.

Material: Stainless Steel (AISI 316)





Accessories

Vikan rubber bands are the hygienic solution to secondary colour coding. The bands fit handles, vacuum cleaner nozzles and all other Vikan products.

- Allow for secondary colour-coded segregation of equipment.
- Metal detection kit is used to check the detectability of Vikan products and calibrate the metal detector accordingly.

Colour Coding Rubber Band x 5 Pcs., Ø26 mm



Item no.: 9801



26 mm



1 Pcs.

Material: Silicone rubber

Colour Coding Rubber Band x 5 Pcs., Ø40 mm



Item no.: 9802



40 mm



1 Pcs.

Material: Silicone rubber





VISSING FONDEN

Vissing Foundation

Owned by the Vissing Foundation

Vikan is ninety percent owned by the Vissing Foundation, a charity established in 1979 by former Vikan owner Mogens Vissing and his wife Jenny.

The Vissing Foundation funds important research in cancer and diabetes treatment, with an emphasis on devices, diagnostic methods, treatment approaches, data analysis and other areas that directly affect patient health and wellbeing. The foundation's work is a source of pride for all of us in the Vikan family.



Get in touch

Your local Vikan Distributor is ready and very well equipped to meet your every need for Vikan products, services, and up-to-date expert knowledge and advice.

Vikan Distributors maintain an exceptionally close relationship with Vikan. They take part in regular training initiatives, and they are happy to offer guidance on what products to use, how to use them effectively, and how to keep auditors and other authorities not just satisfied, but impressed with, your operation.

No matter where in the world you do business, you'll find a Vikan Distributor nearby.



Contact Us

Vikan international

Islands Brygge 39, 2. sal
DK-2300 København
Denmark

Tel.: +45 96 14 26 10

export@vikan.com

